

INSTALLASJONSMANUAL

## VikingBad Liam Rett Dør

### Seksjon F : Nisje 135° med fast magnetprofil

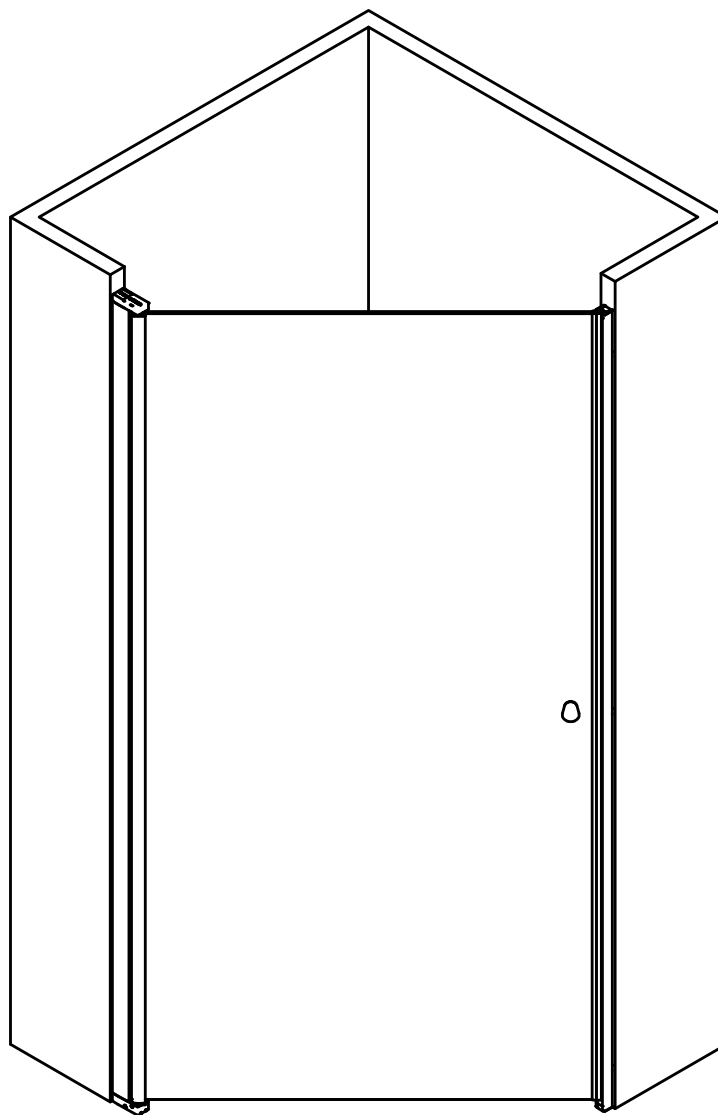

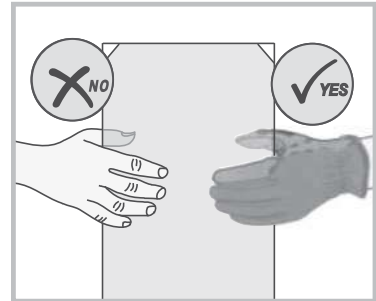
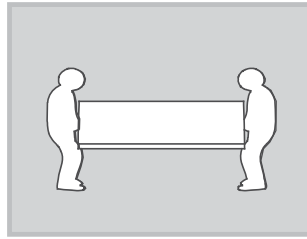
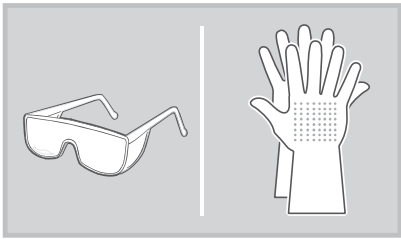
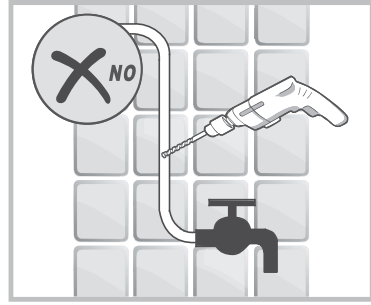
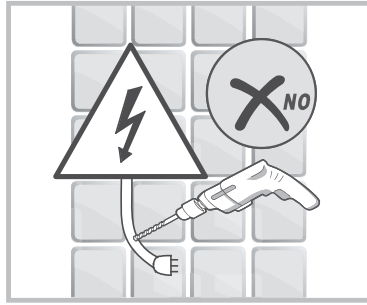
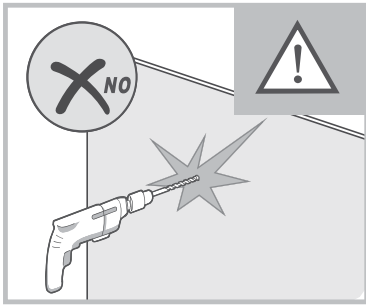

Liam dusjdør skal monteres på ett fast underlag og kan ikke henges på vegg uten understøttet bunn hengsle.

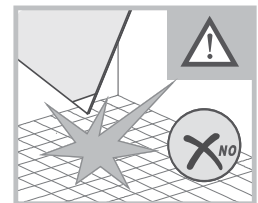
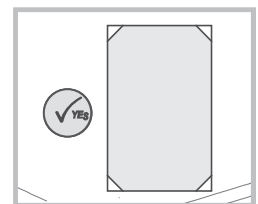
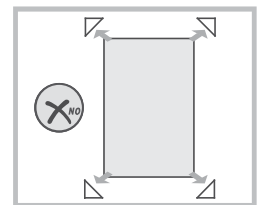
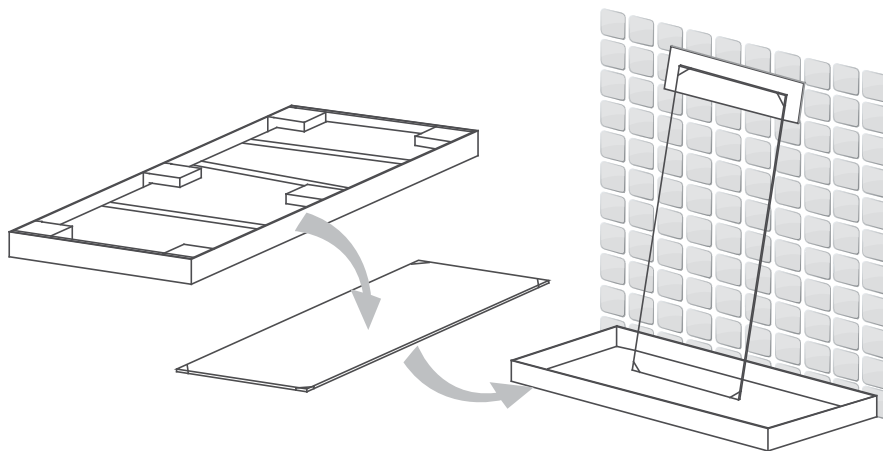
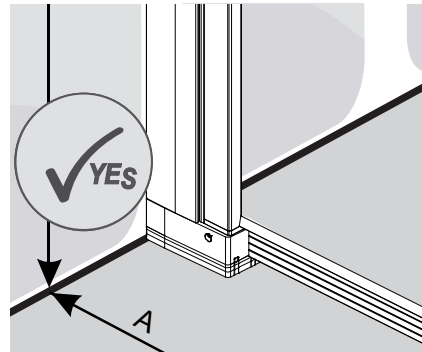
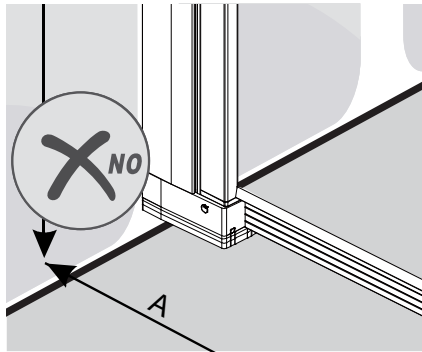

# Gjennomføring av utenpåliggende rør

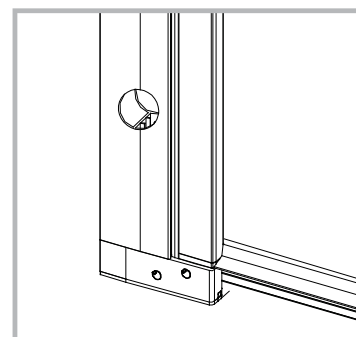
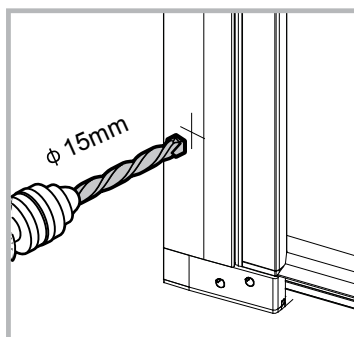
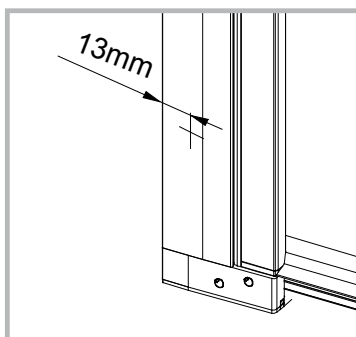
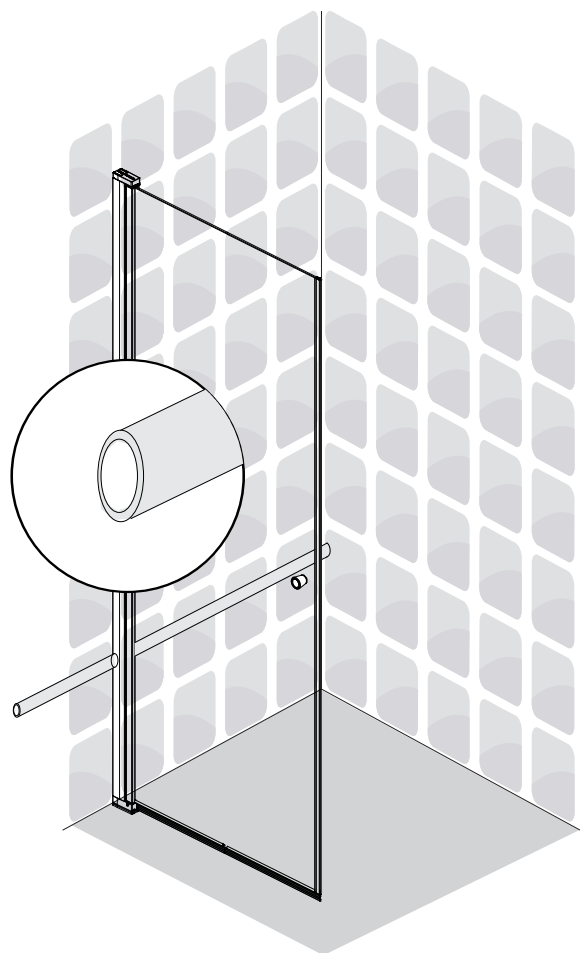

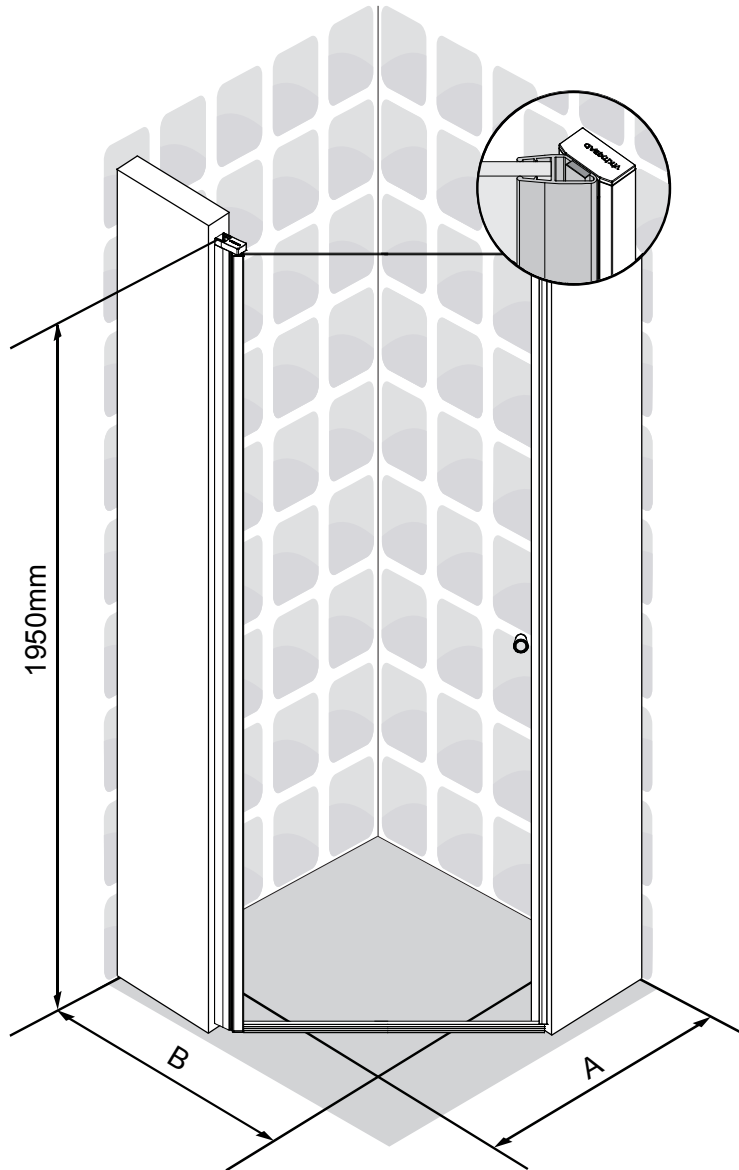
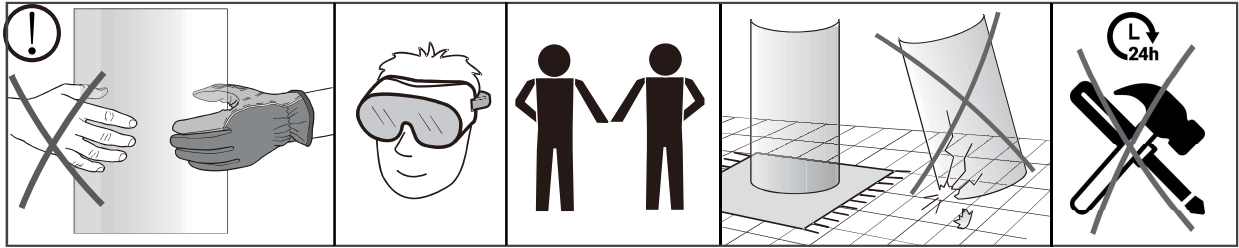

	A	B	
		Min	Max
600	391	431	456
700	461	502	527
800	532	573	598
900	603	643	668
1000	673	714	739

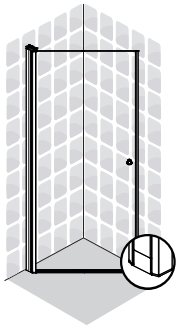

CTN1/2

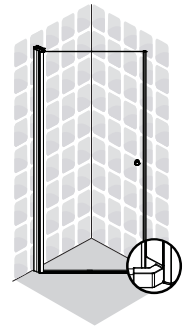
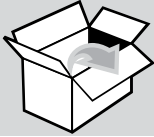

CTN1/2/3

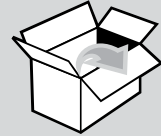

CTN1

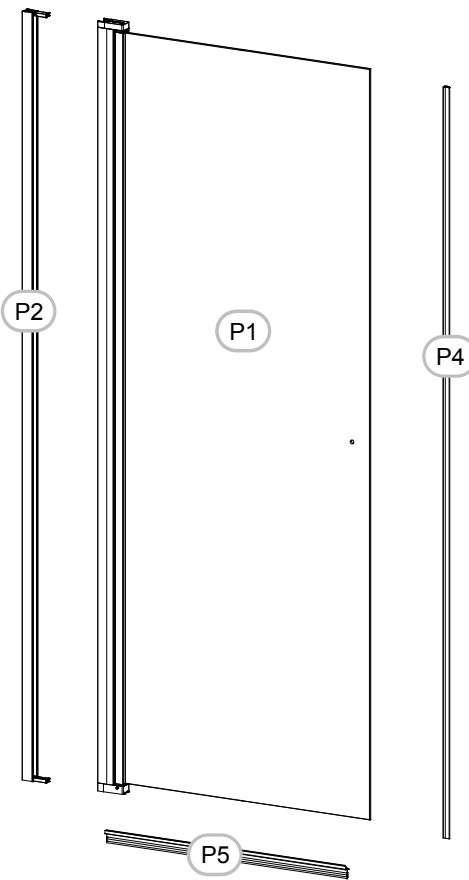
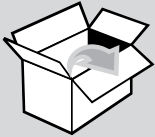

CTN2

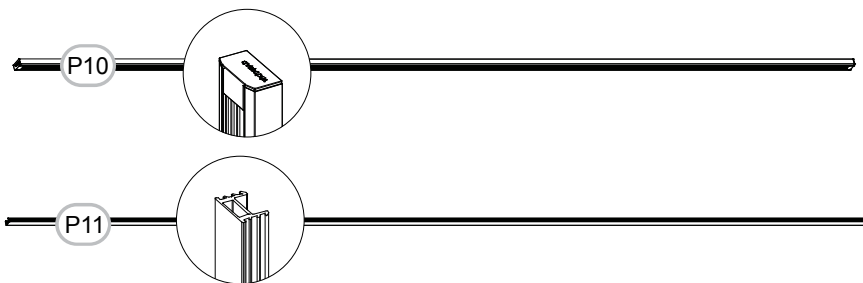

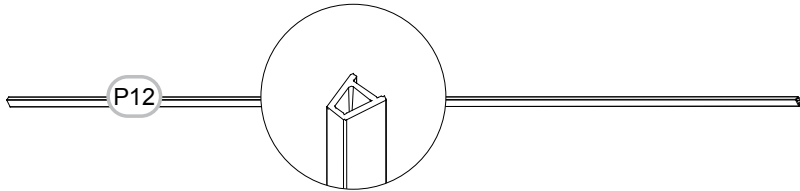
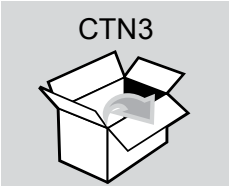

CTN1

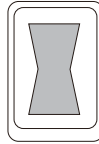
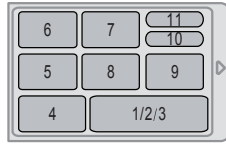
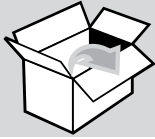

1

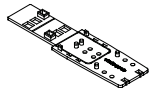

2mm

x1

2

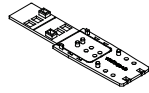

3mm

x1

3

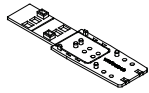

4mm

x1

4

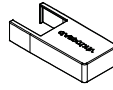

x1

5



x4

6



x4

7



x4

8



x4+2

9



x1

10

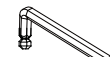

2.5mm

x1

11

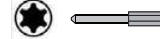

x1

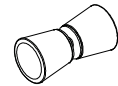

x1

CTN3

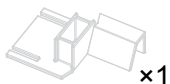
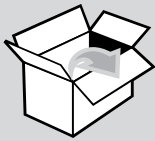

x1

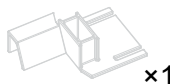

x1

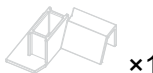

x1



x1

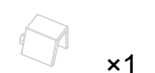

x1



x1



x1



x1



x1

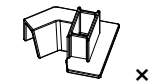

x1

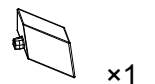

x1

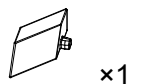

x1

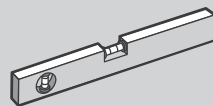
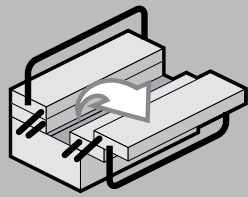

Ø6mm

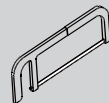
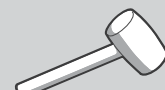
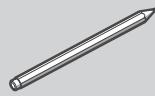
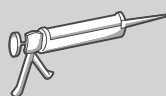

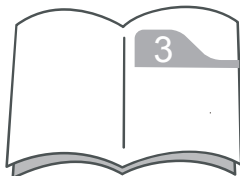
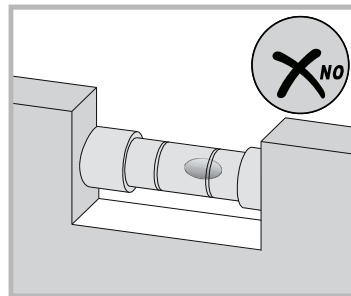
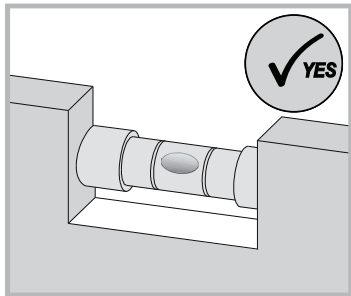
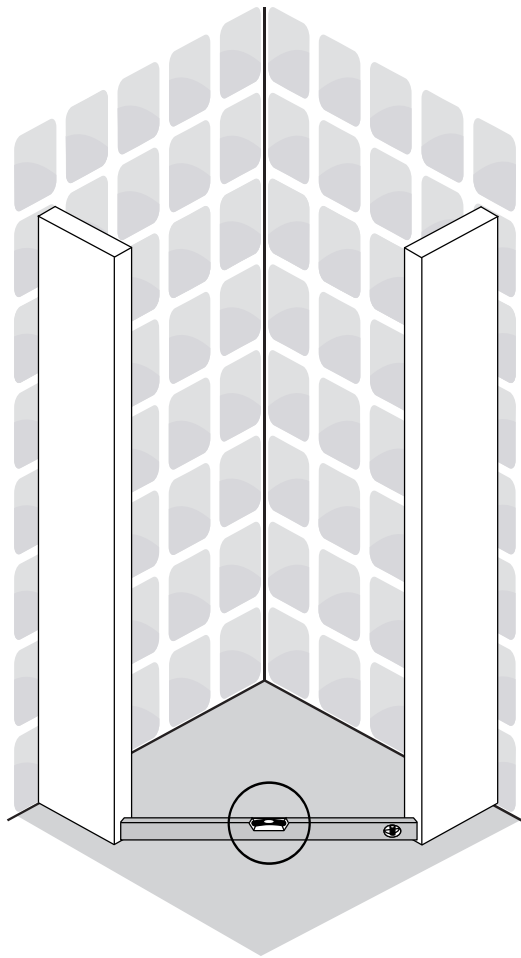



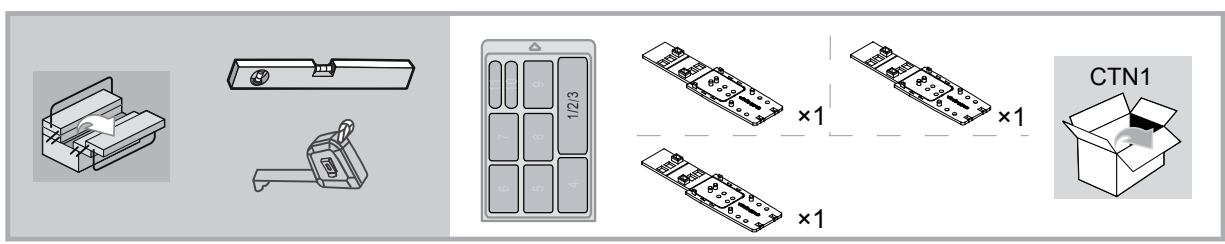
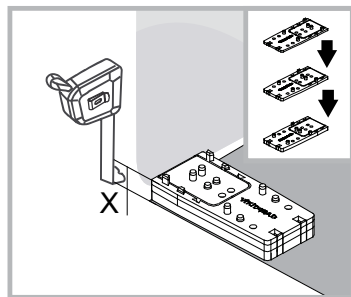
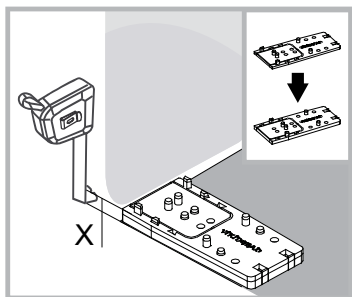
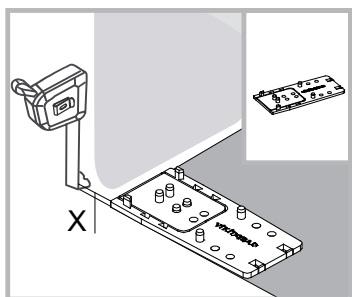
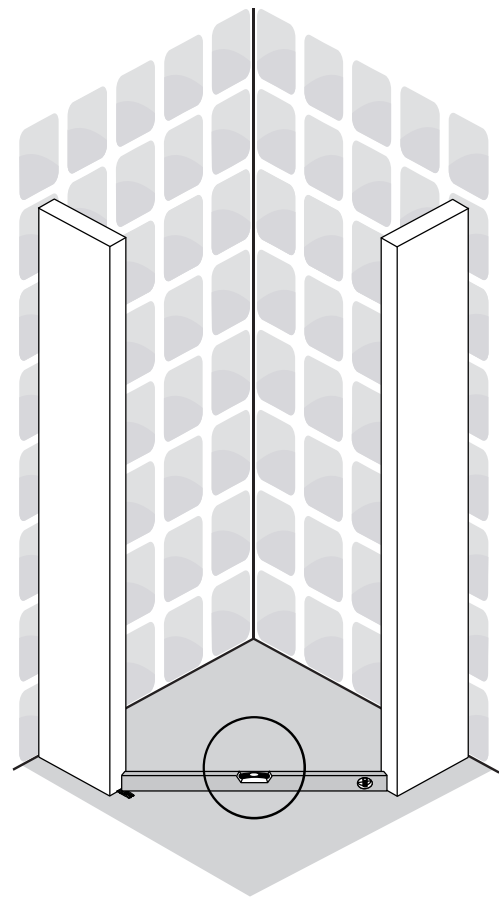
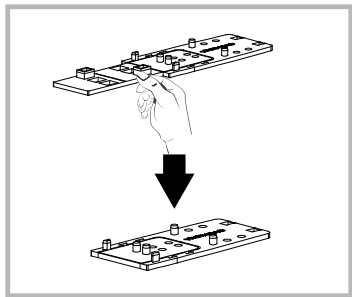
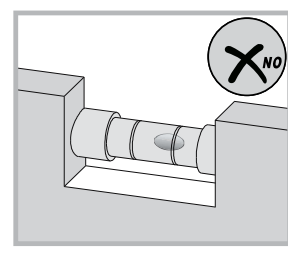
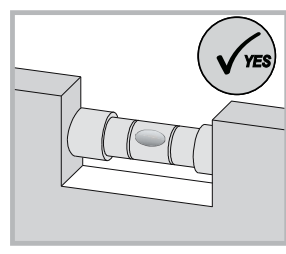
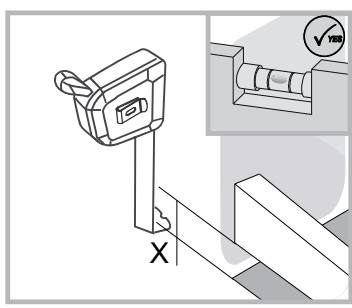

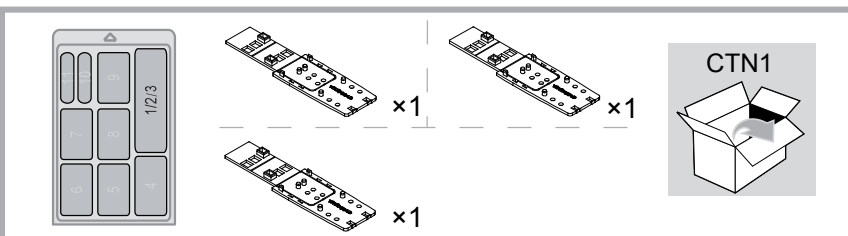
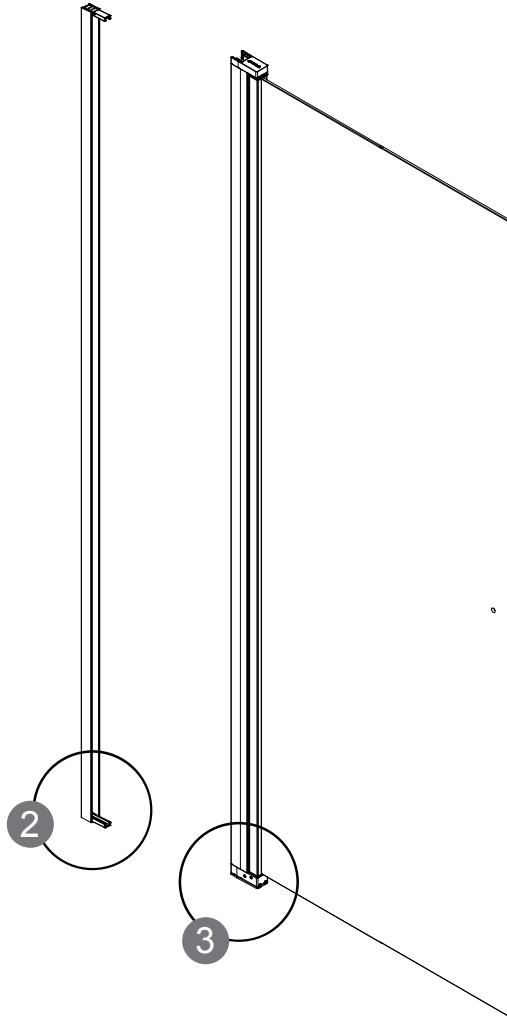
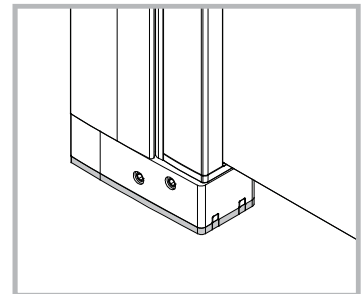
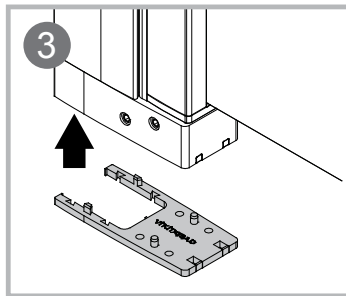
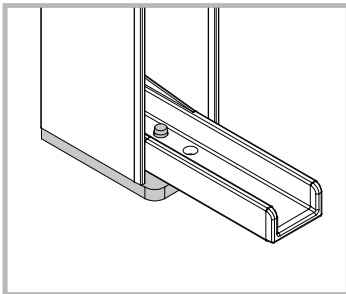
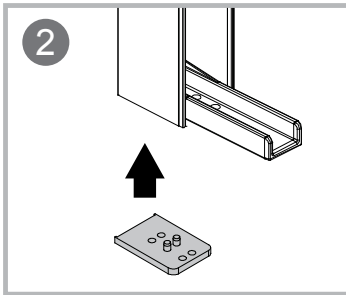
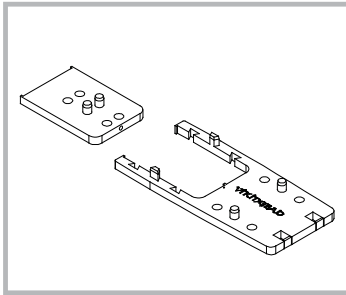
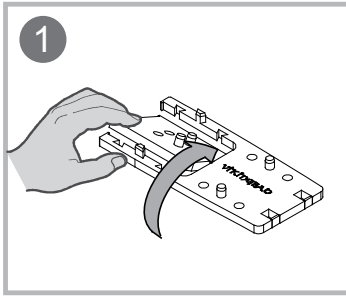

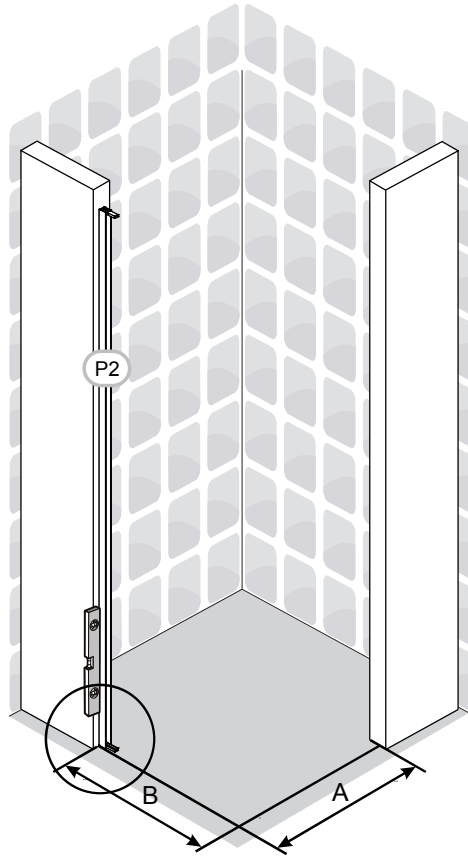
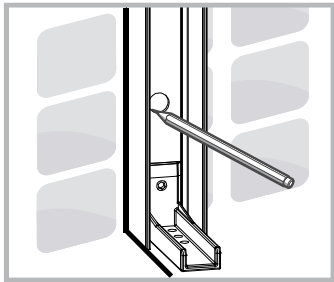
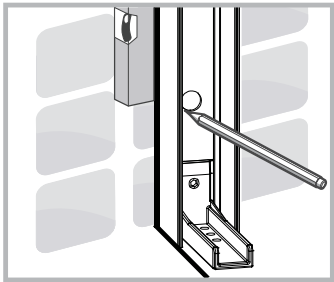
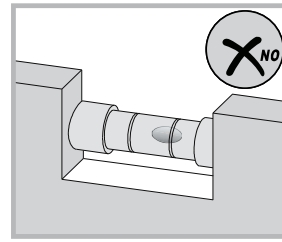
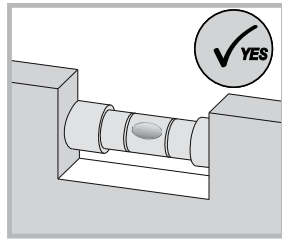
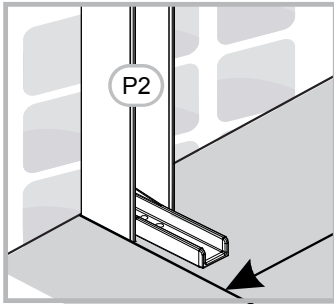

	A	B	
		Min	Max
600	391	431	456
700	461	502	527
800	532	573	598
900	603	643	668
1000	673	714	739

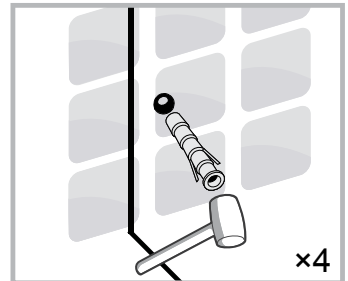
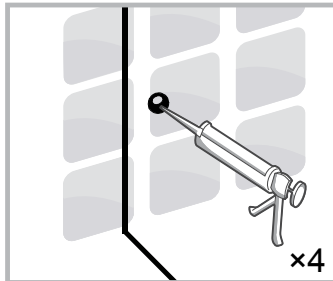
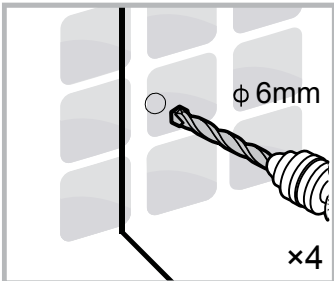
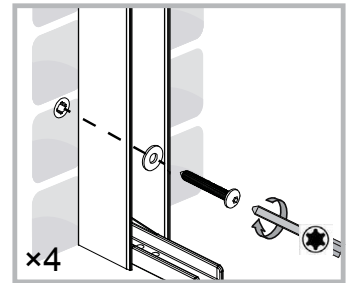

11	12	13
7	8	12/3
6	5	4

P2 — x1

x4

x4

x1

x4

x4

x1

CTN1

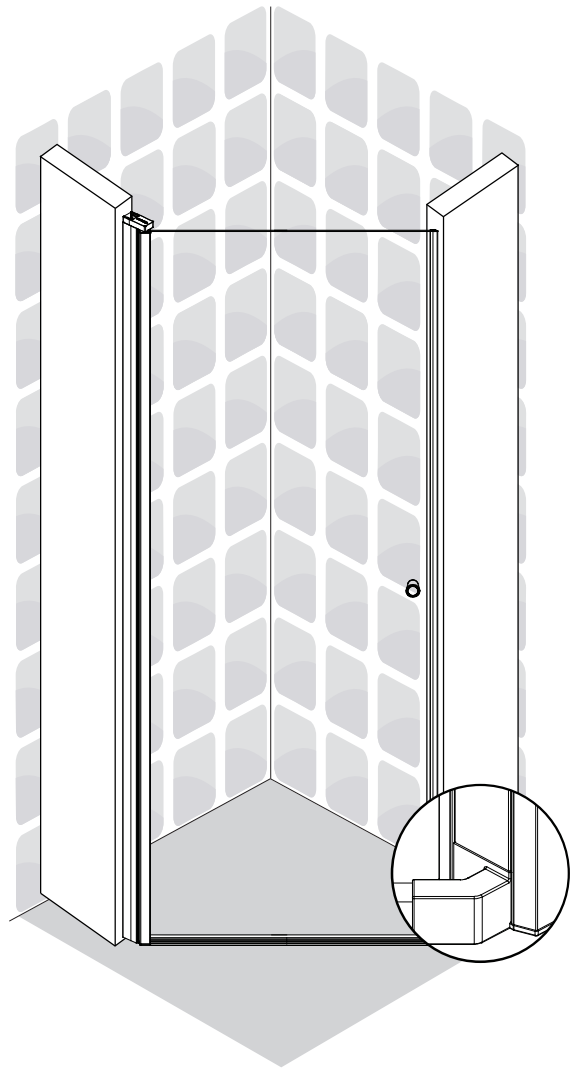
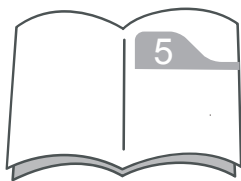
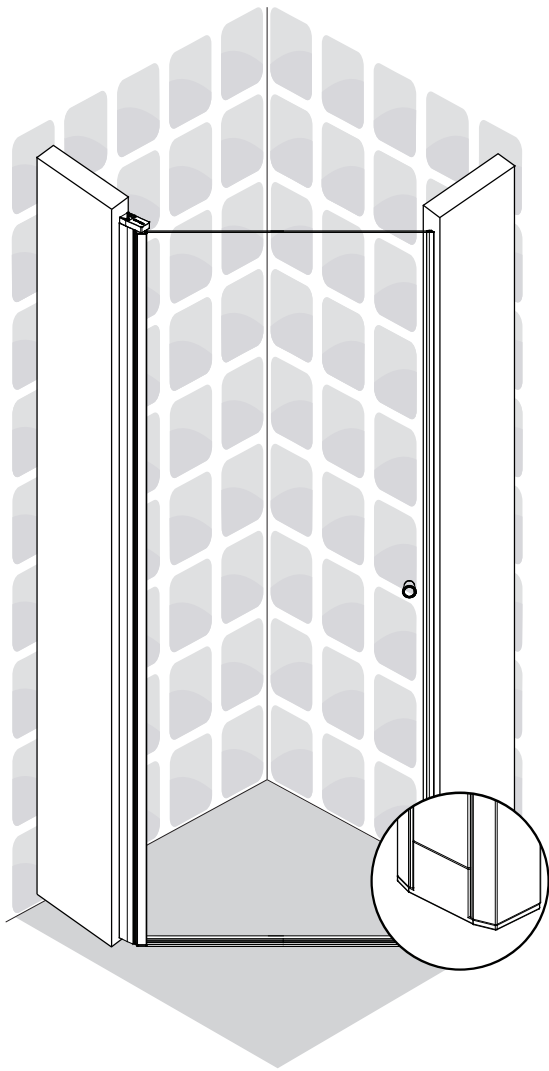

4

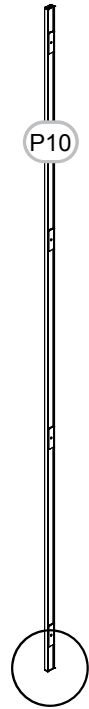
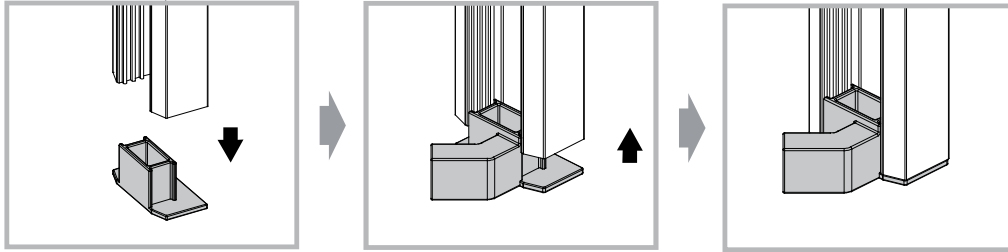

5

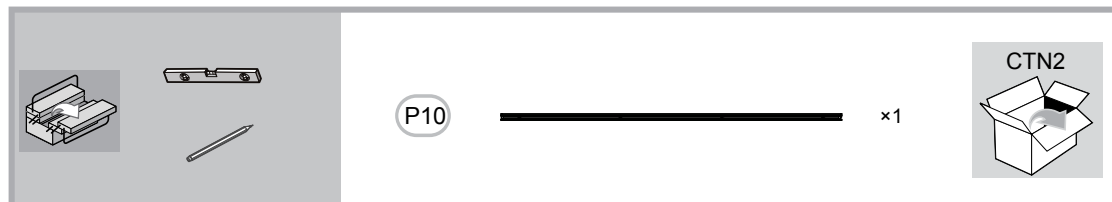
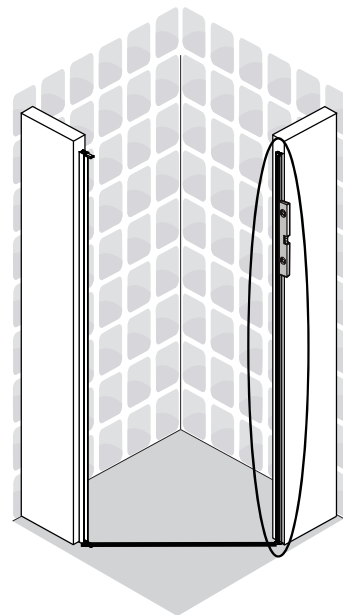
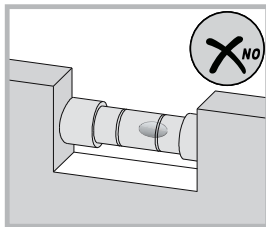
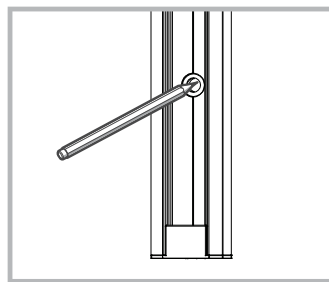
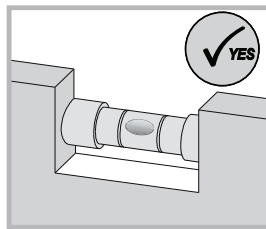
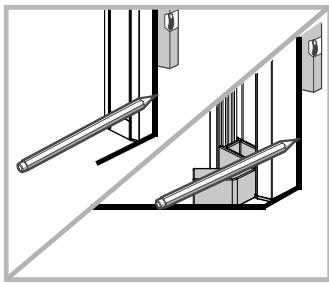

6

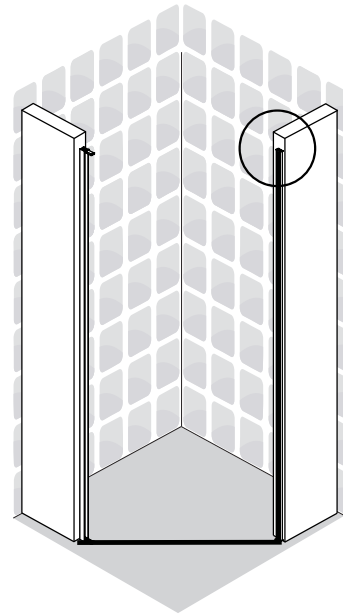
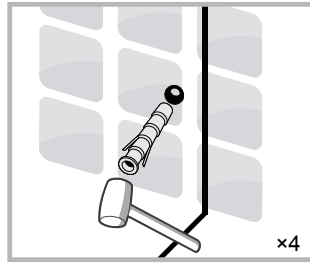
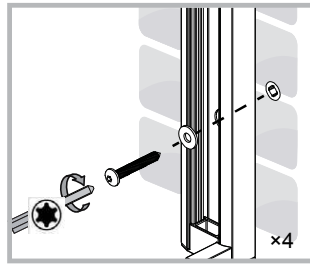
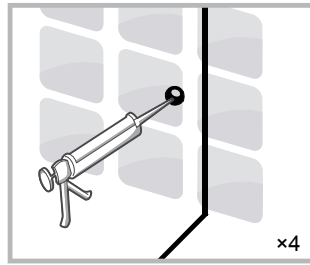
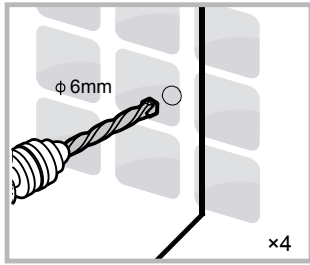

7

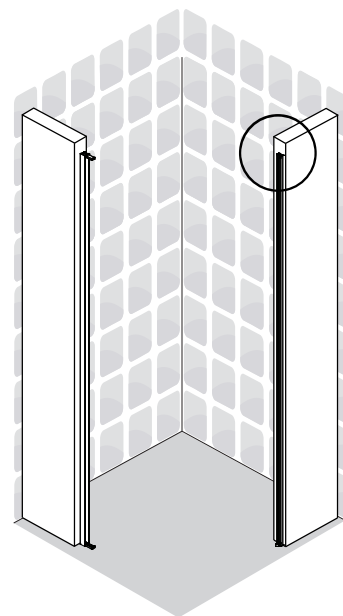
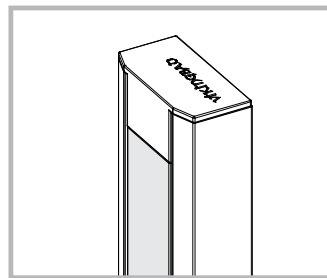
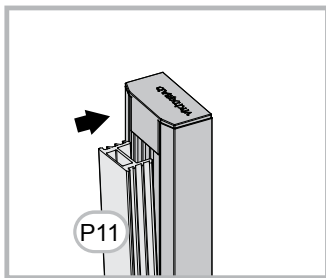

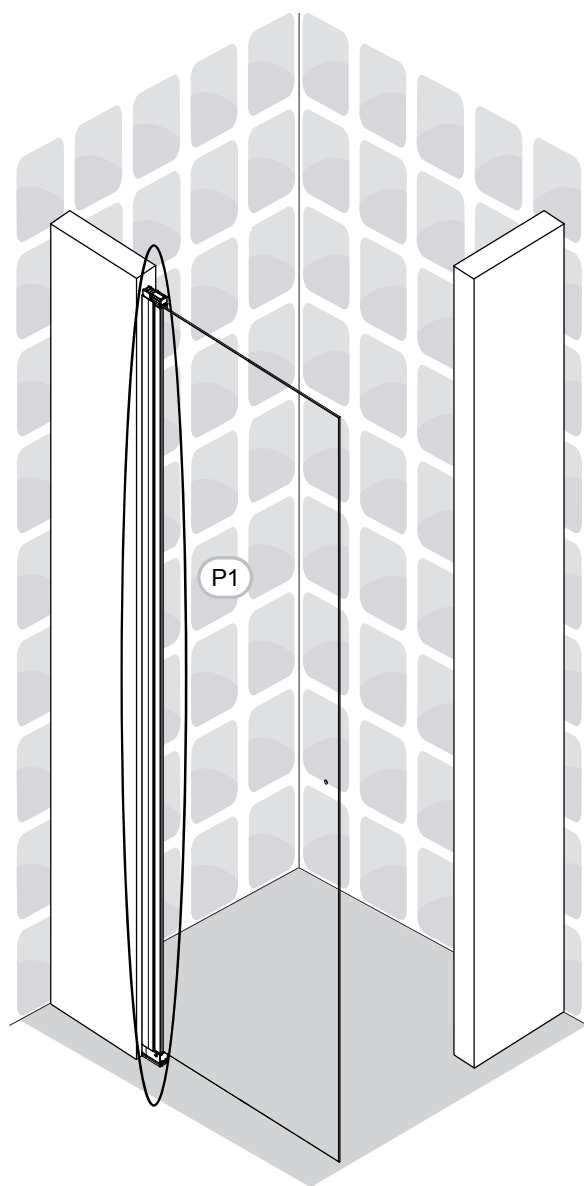
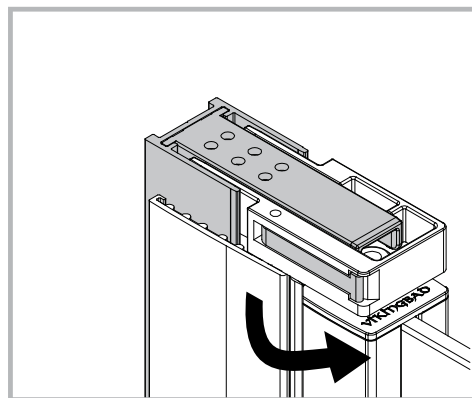
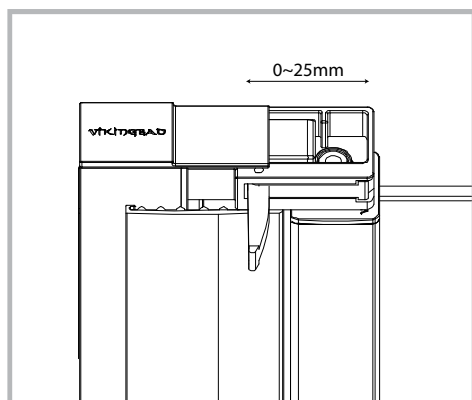
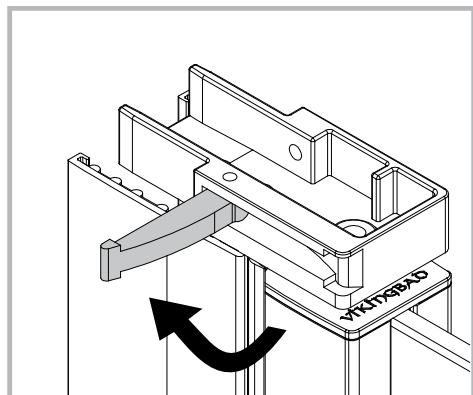

P1

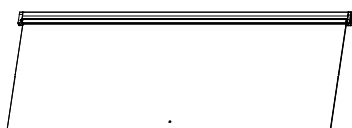

x1

CTN1

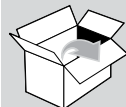

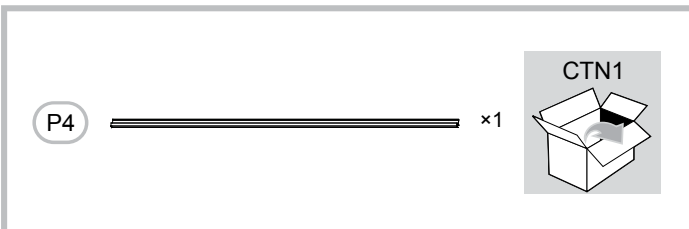
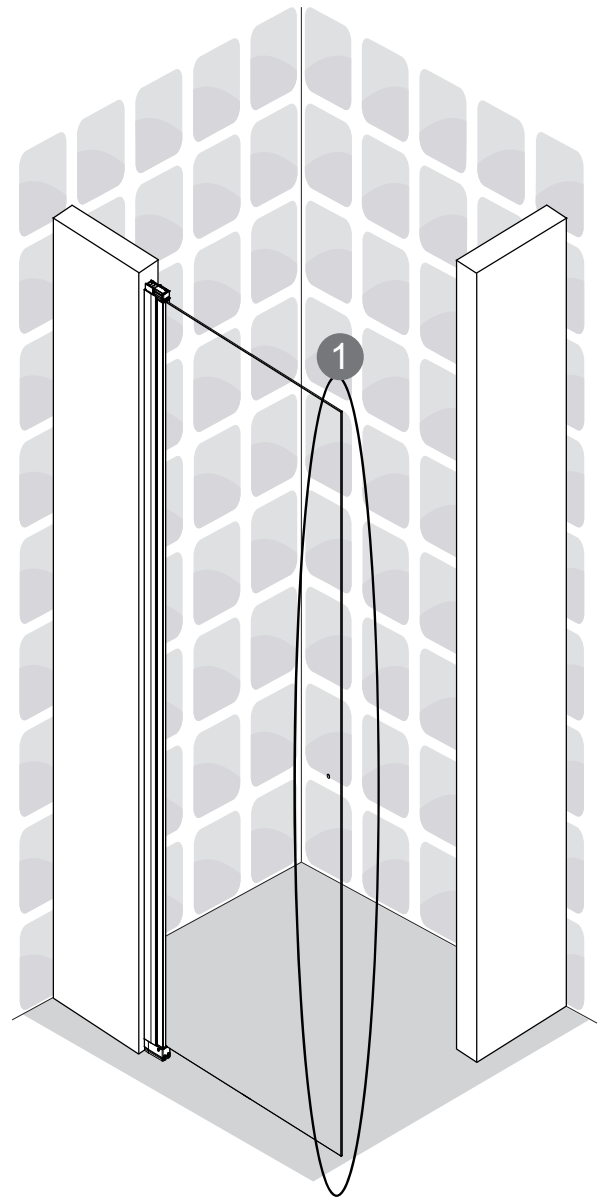
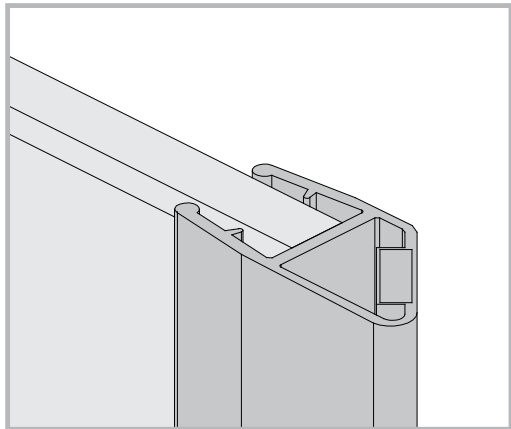
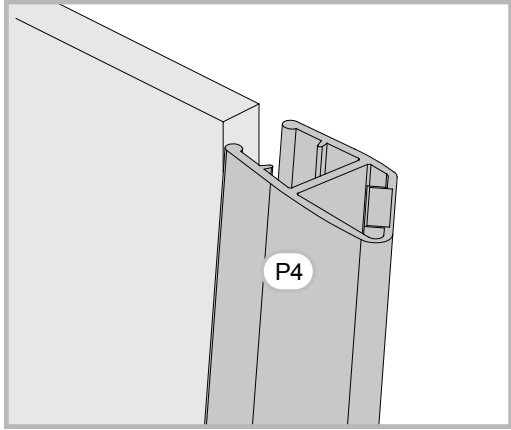



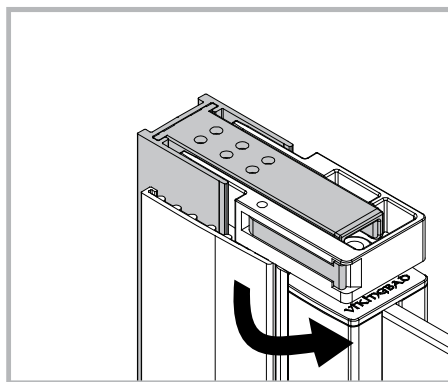
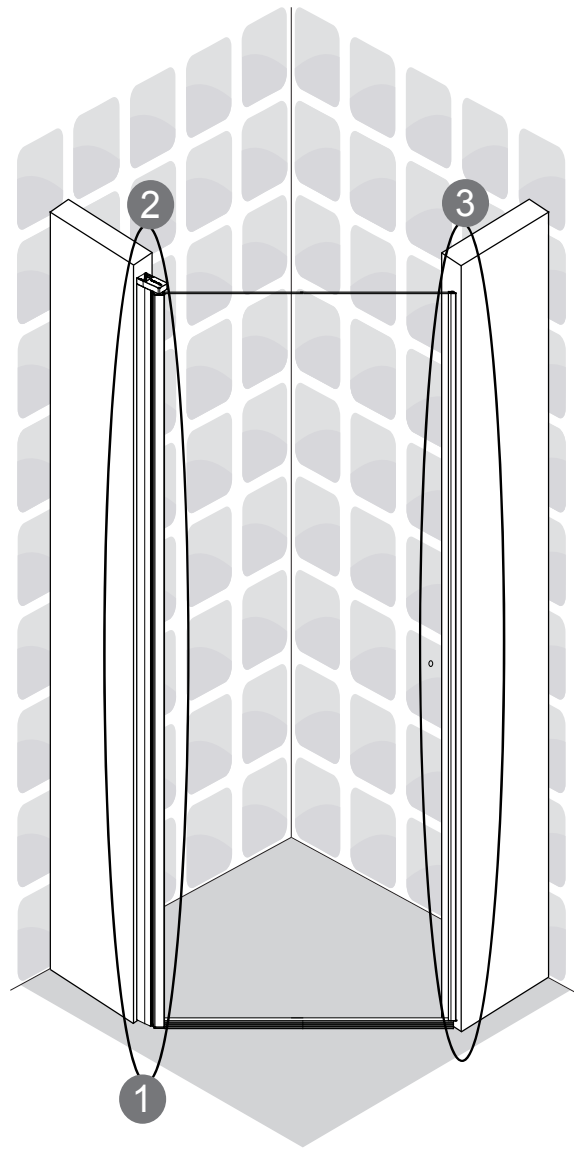
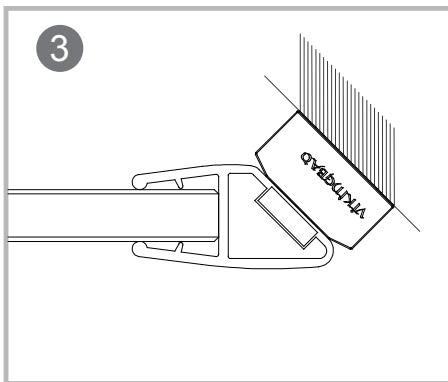
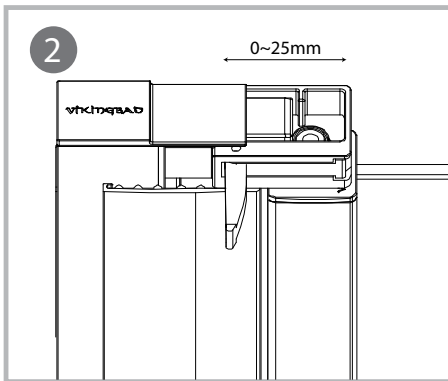
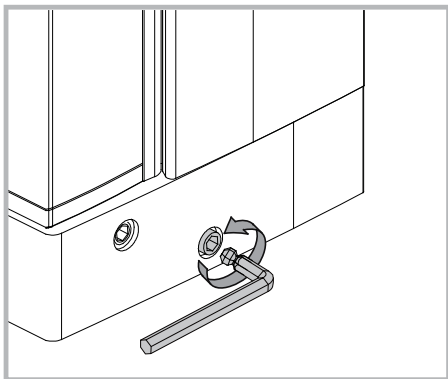
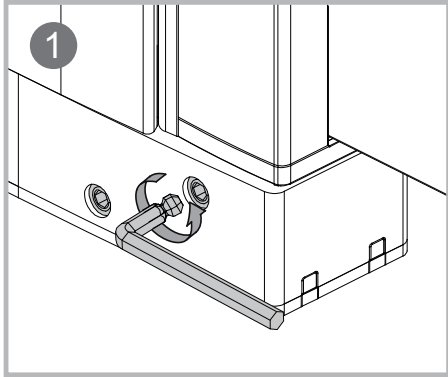

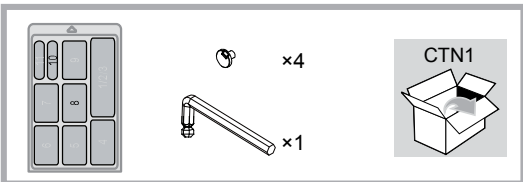
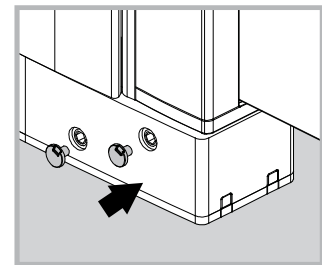
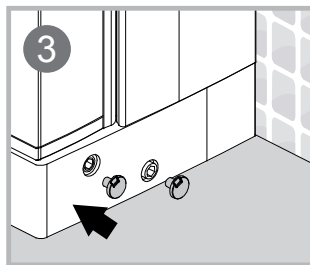
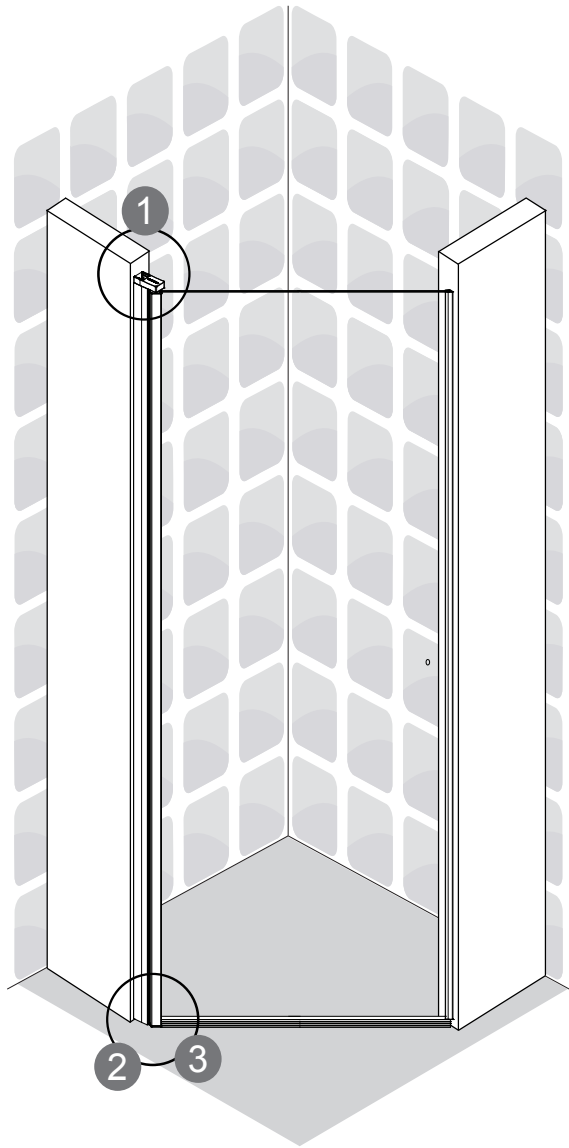
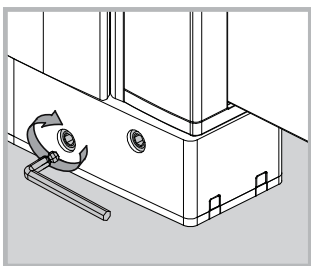
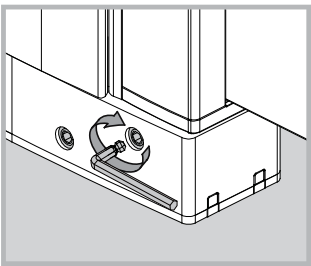
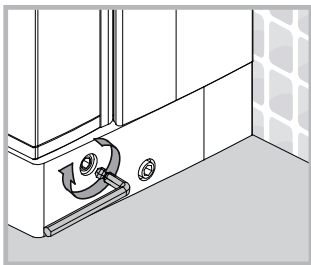
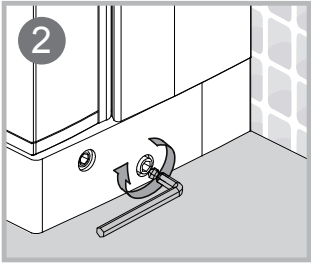
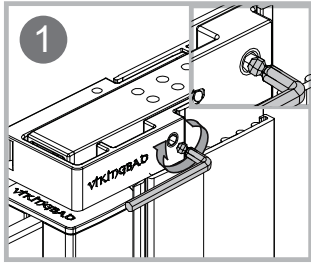

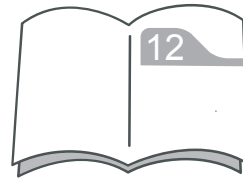
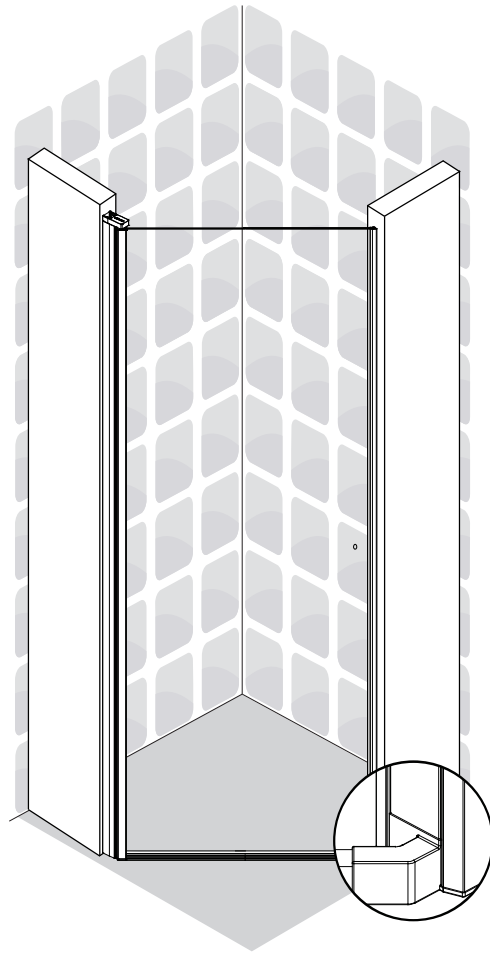
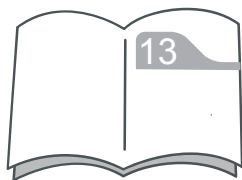
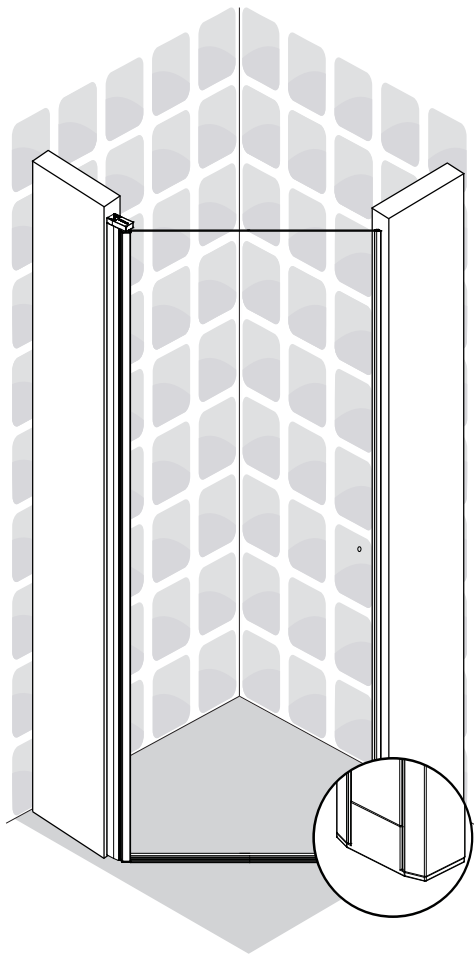

12

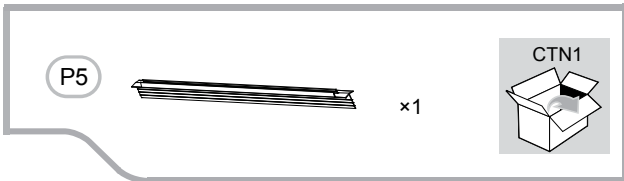
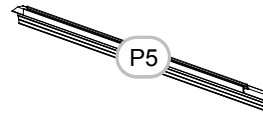
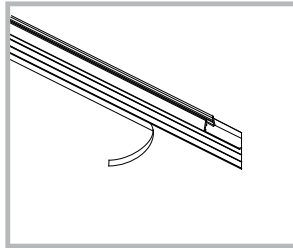
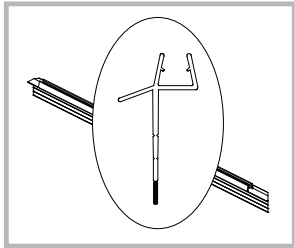

13

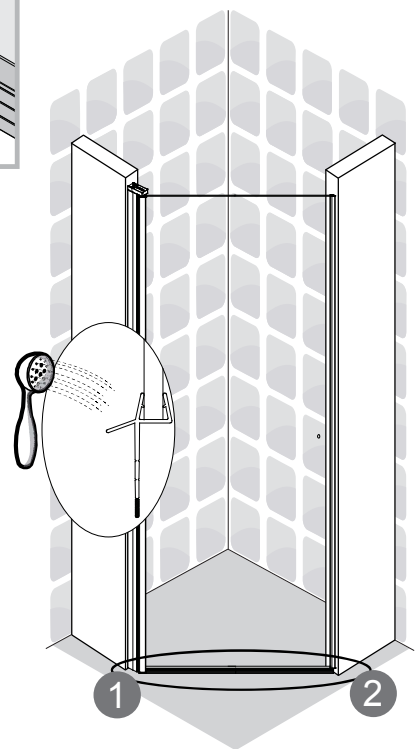
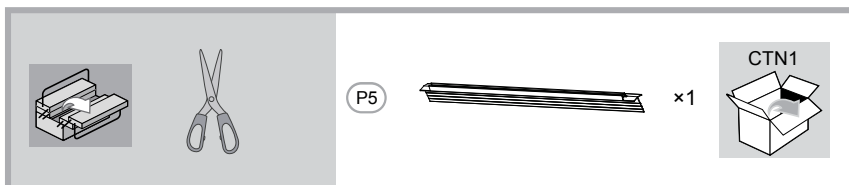
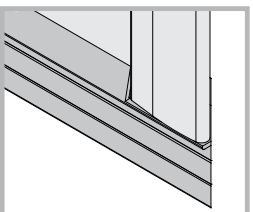
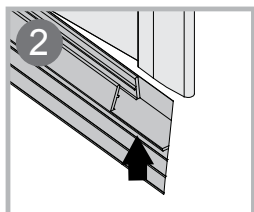
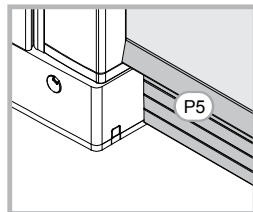
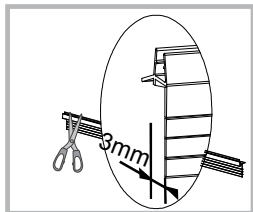
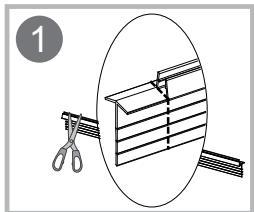

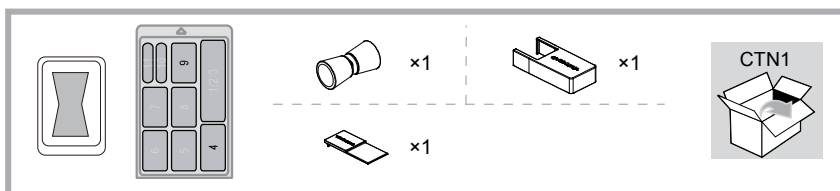
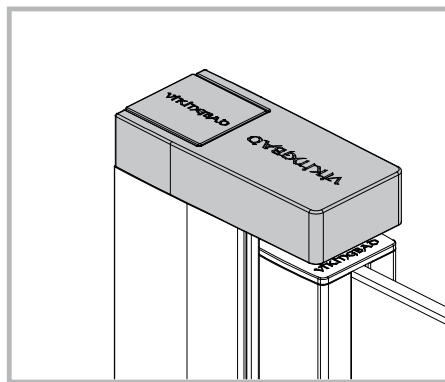
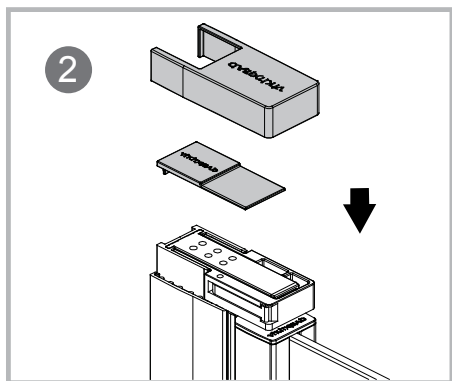
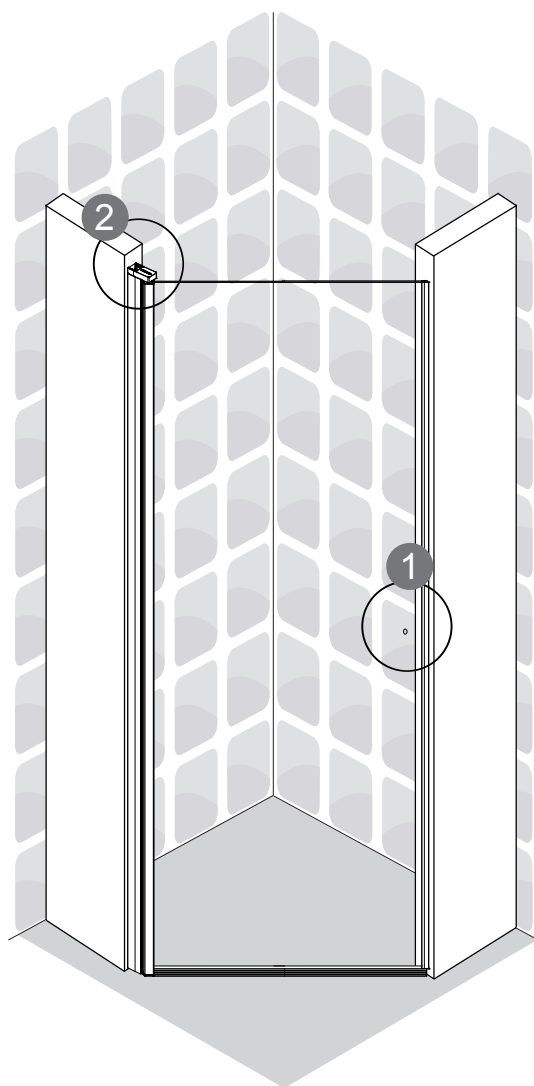
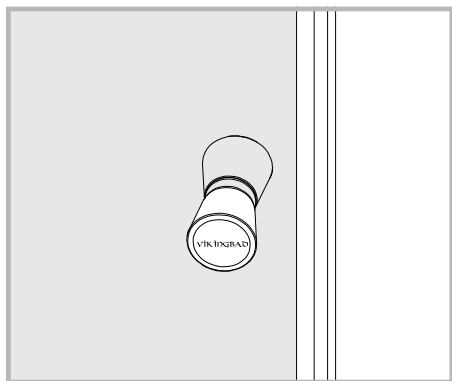
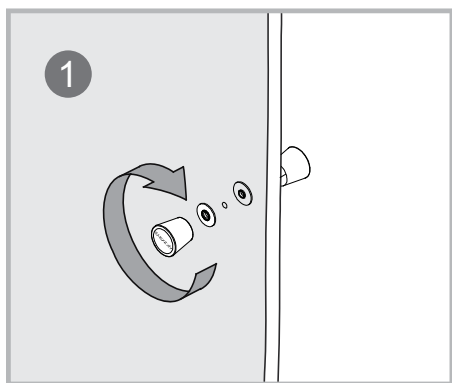

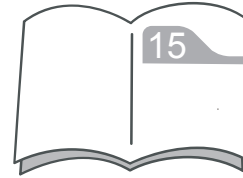
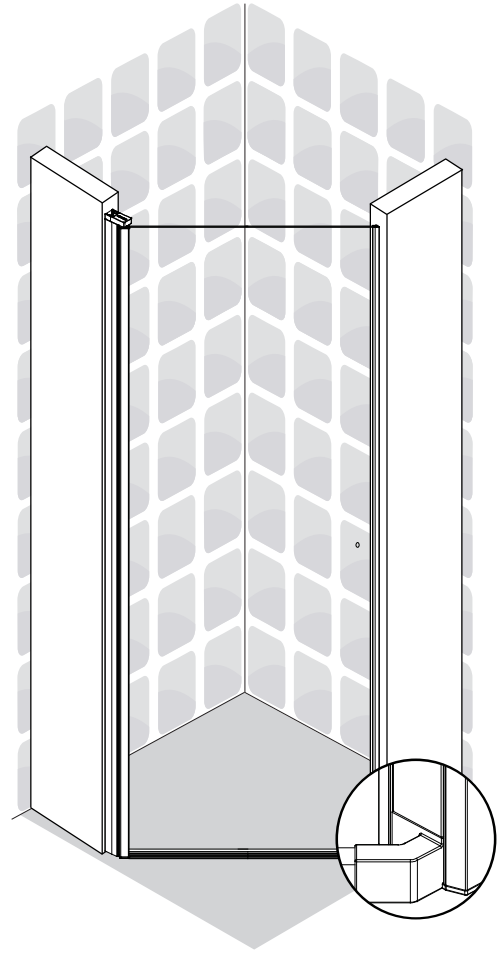
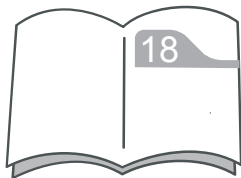
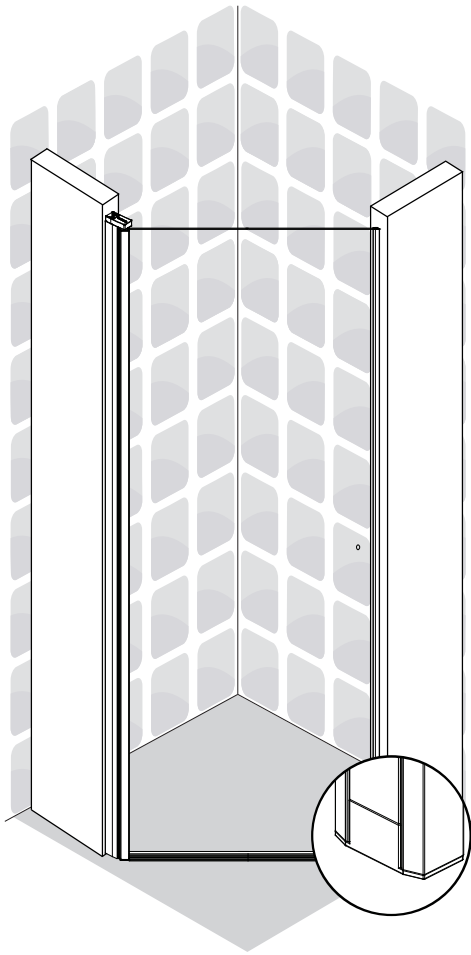

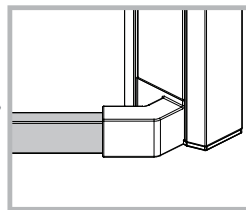
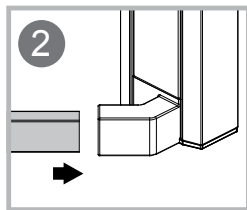
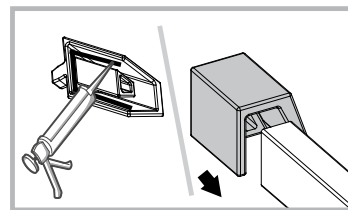
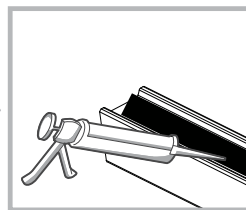
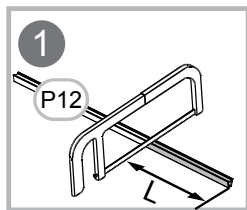
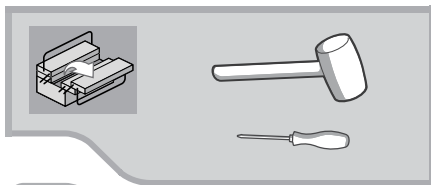
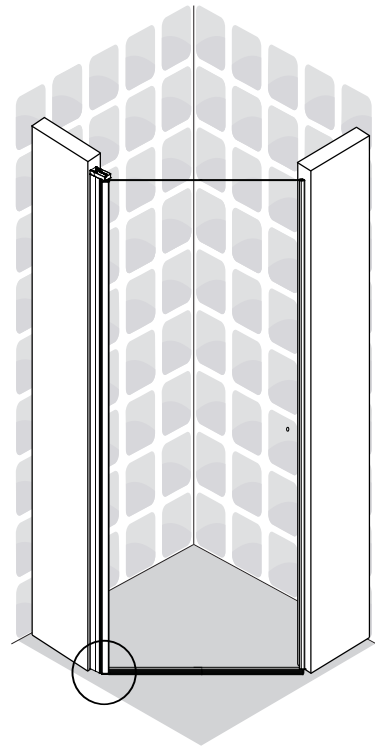
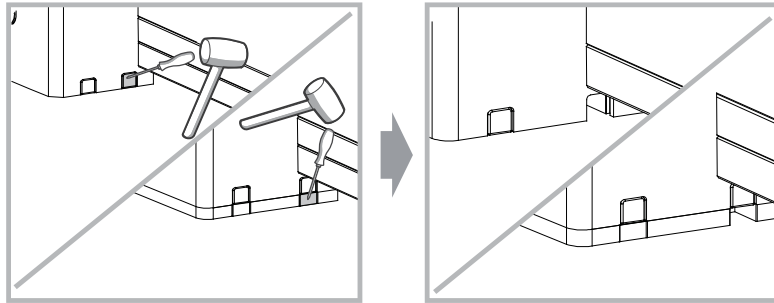

A	L
600	493
700	593
800	693
900	793
1000	893

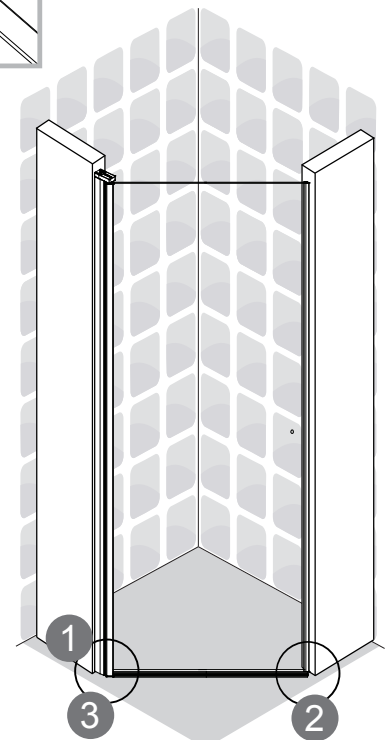
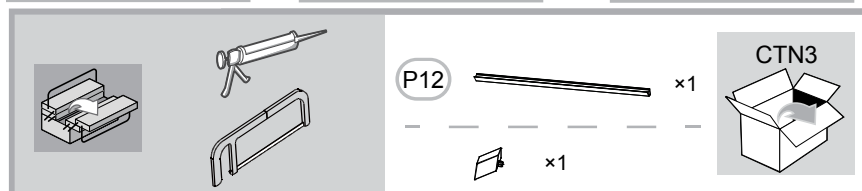
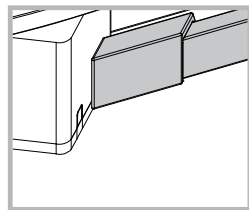
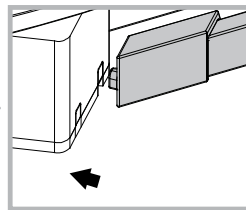
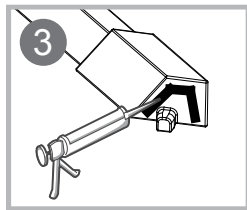

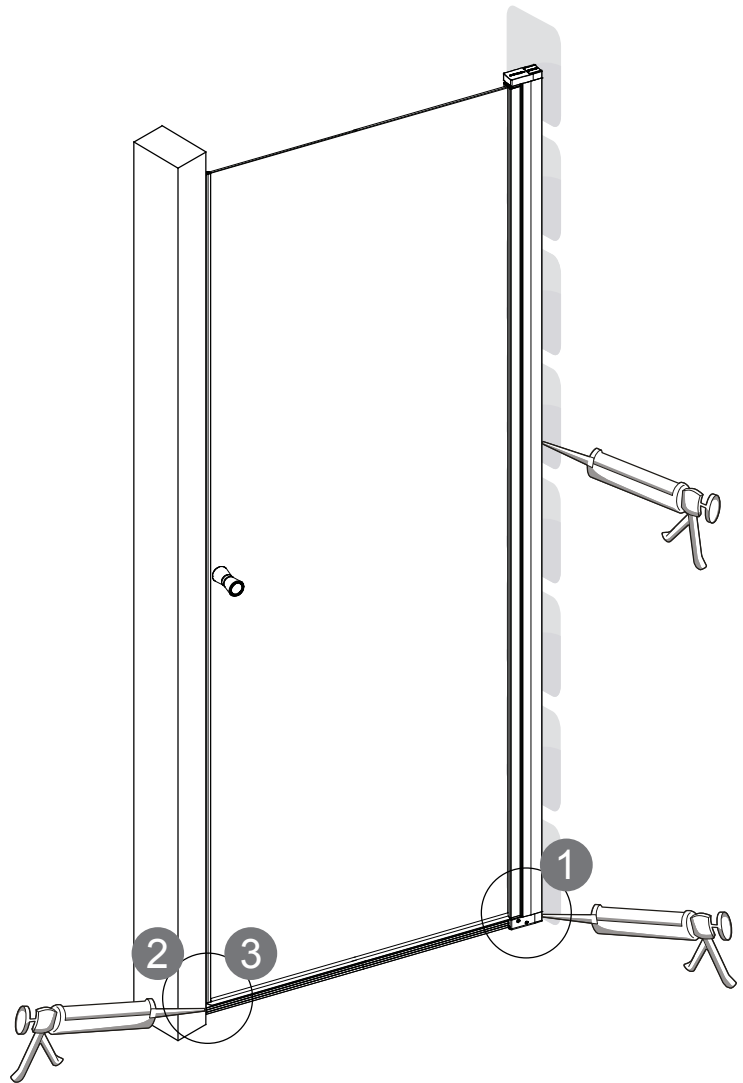
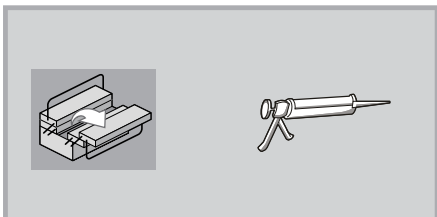
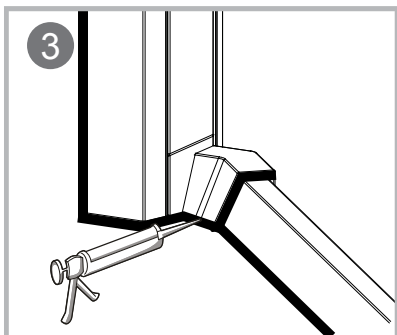
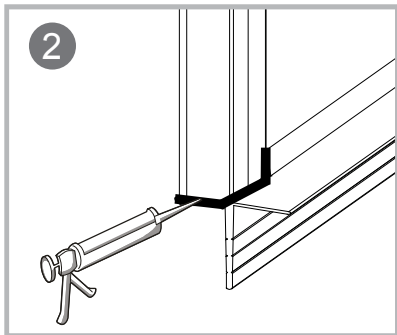
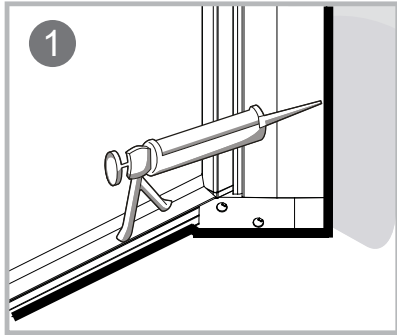
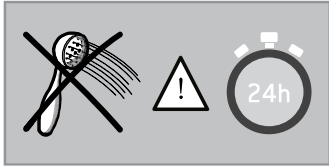



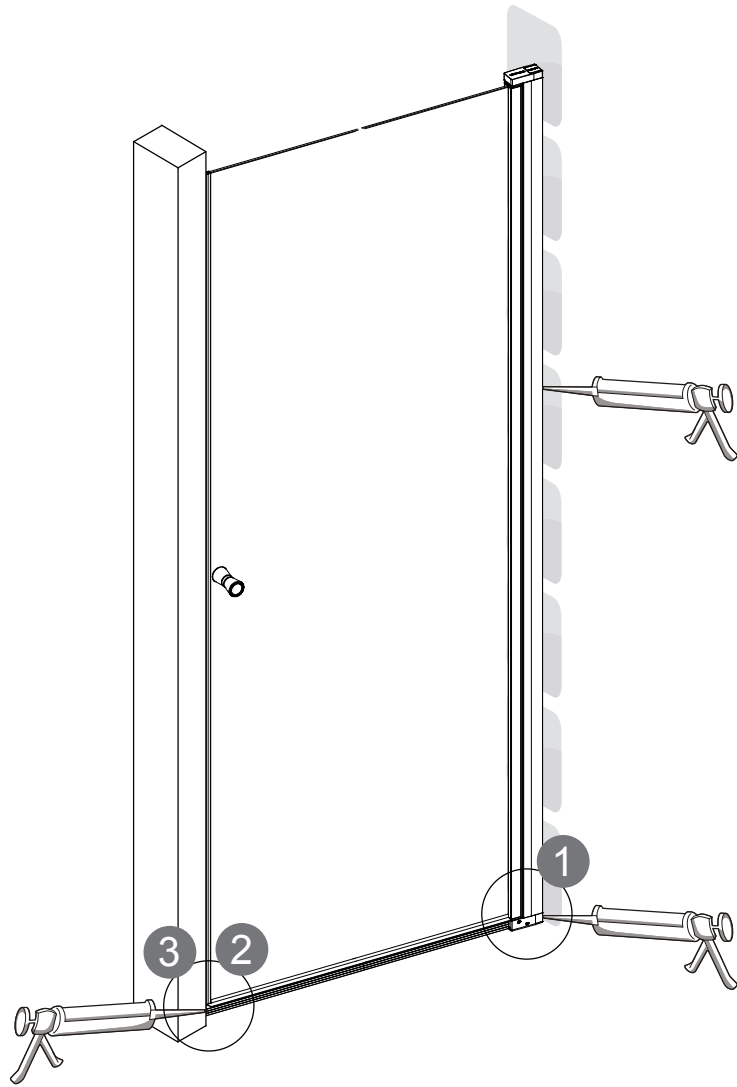
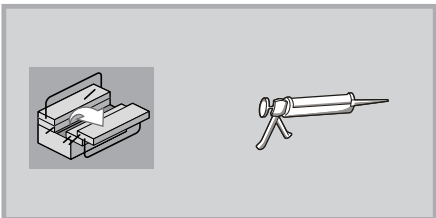
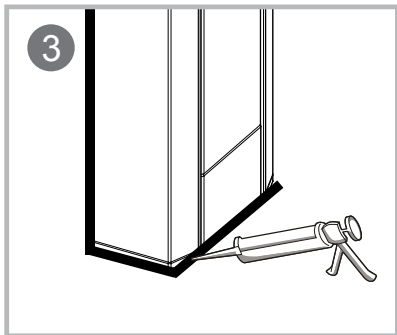
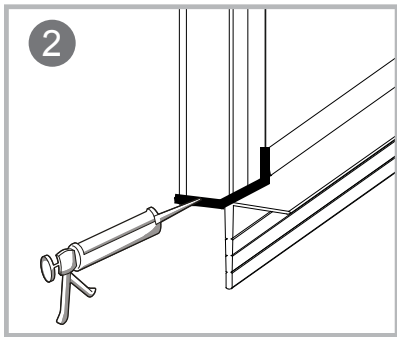
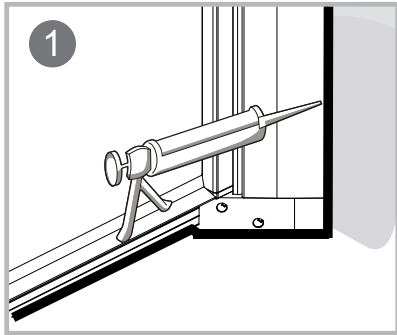
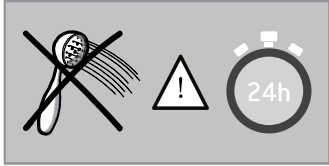

## VEDLIKEHOLD

Under følger generelle vedlikeholdsinstruksjoner for å holde produktet vedlike:

- ✓ Vi anbefaler rengjøring med vaskemidler beregnet for badet. Bruk en myk klut og unngå bruk av f.eks skuresvamp da dette kan lage riper på produktet. Vann og såperester tørkes av umiddelbart. Unngå: Rengjøringsmiddel med skure-effekt eller innholdende løsmidler! Eksempel: Syrer, klorin, kaustisk soda og amoniakk (salmiak) må ikke brukes!
- ✓ Det er anbefalt å behandle innvendige glassflater med Invisible Shield Gel regelmessig. Dette polerer glasset og vil forenkle rengjøring av dusjen.
- ✓ Det er anbefalt å bruke en dusjnal for å fjerne vann fra overflater etter bruk. Dette vil forenkle det daglige vedlikeholdet.

## GARANTIVILKÅR

VikingBad AS følger norsk kjøpslov med 5 års reklamasjonsrett på fabrikkfeil.

### VED REKLAMASJON / SERVICE

Arbeid dekket av VikingBad AS:

- ✓ Transport tur/retur til kunde.
- ✓ Selve servicearbeidet med reservedeler/ reklamasjonsproduktet.
- ✓ Gjenmontering og silikonerings.

### HVA ER IKKE DEKKET AV KJØPSLOV ELLER GARANTI:

- ✓ Alle følgefeil forårsaket av frostskader som kunde kunne forhindre dekket ikke av reklamasjon
- ✓ Feil som følge av fysisk skade eller ytre påvirkning
- ✓ Feil/skader som følge av feil montering/tilkobling/reparasjoner/endringer av uautorisert personell eller bruk av ikke-originale reservedeler i forbindelse med service/reparasjon.
- ✓ Kostnader som VikingBad AS ikke er direkte skyld i, som f.eks tap av fortjeneste eller annen skade på person/eiendom.
- ✓ Skade/feil på produktet som skyldes feil bruk eller som er i strid med prosedyrer beskrevet i denne brukermanualen.
- ✓ Skraper/riper i overflaten ansees som vanlig slitasje.
- ✓ Skader oppstått grunnet bruk av ikke-anbefalte vaskemidler. Eks syrer og vaskemidler med slipende effekt
- ✓ VikingBad AS fraskriver seg ansvaret for kostnader i forbindelse med reklamasjoner, service eller annet utover selve produktet.

### VIKTIG MED TANKE PÅ REKLAMASJON:

Produktet må være tilgjengelig for serviceperson ved reklamasjon. Det er kjøpers ansvar å sørge for at produktet er tilgjengelig. Dersom fliser, toalett, badromsmøbler eller lignende må demonteres eller eventuelt produkt må løftes opp/ut av innbygning for at serviceperson skal komme til selve produktet påligger dette ansvaret på kjøper. Tid serviceperson bruker for å gjøre produktet tilgjengelig for service/reklamasjon inngår ikke i garanti og faktureres etter timepris.

### GARANTI GJELDER KUN SAMMEN MED GYLDIG KVITTERING OG SERIENUMMER I DET LAND PRODUKTET ER KJØPT.

Denne brukermanualen og innholdet kan endres uten varsel. Selv om VikingBad AS har utarbeidet brukermanualen så nøyaktig som mulig, vil ikke VikingBad AS være økonomisk ansvarlig for tap og skader som følge av feilaktig installasjon, service eller bruk. VikingBad AS tar også forbehold om produktendringer og trykkfeil i brukermanualen.

## Samsvarserklæring VikingBad

Leverandør: VikingBad AS  
Østerskogen 35  
4879 Grimstad  
NORWAY

Produktbeskrivelse: VikingBad Liam Dusjdør rett

Modeller: VB-001373-01, VB-001373-02, VB-001373-03, VB-001373-04, VB-001373-05, VB-001374-01, VB-001374-02, VB-001374-03, VB-001374-04, VB-001374-05

VikingBad AS bekrefter at ovennevnte produkter er testet og funnet i samsvar med følgende teststandard:

EN 12600  
EN 14428:2015+A1:2018



A handwritten signature in black ink, reading 'Kristian Schlanbusch'. The signature is written in a cursive style and is positioned above the printed name and title.

Kristian Schlanbusch  
Produktansvarlig VikingBad as

2018.12.18