

INSTALLASJONSMANUAL

# VikingBad Liam Rett DusjDør

## Seksjon A : Dusjhjørne

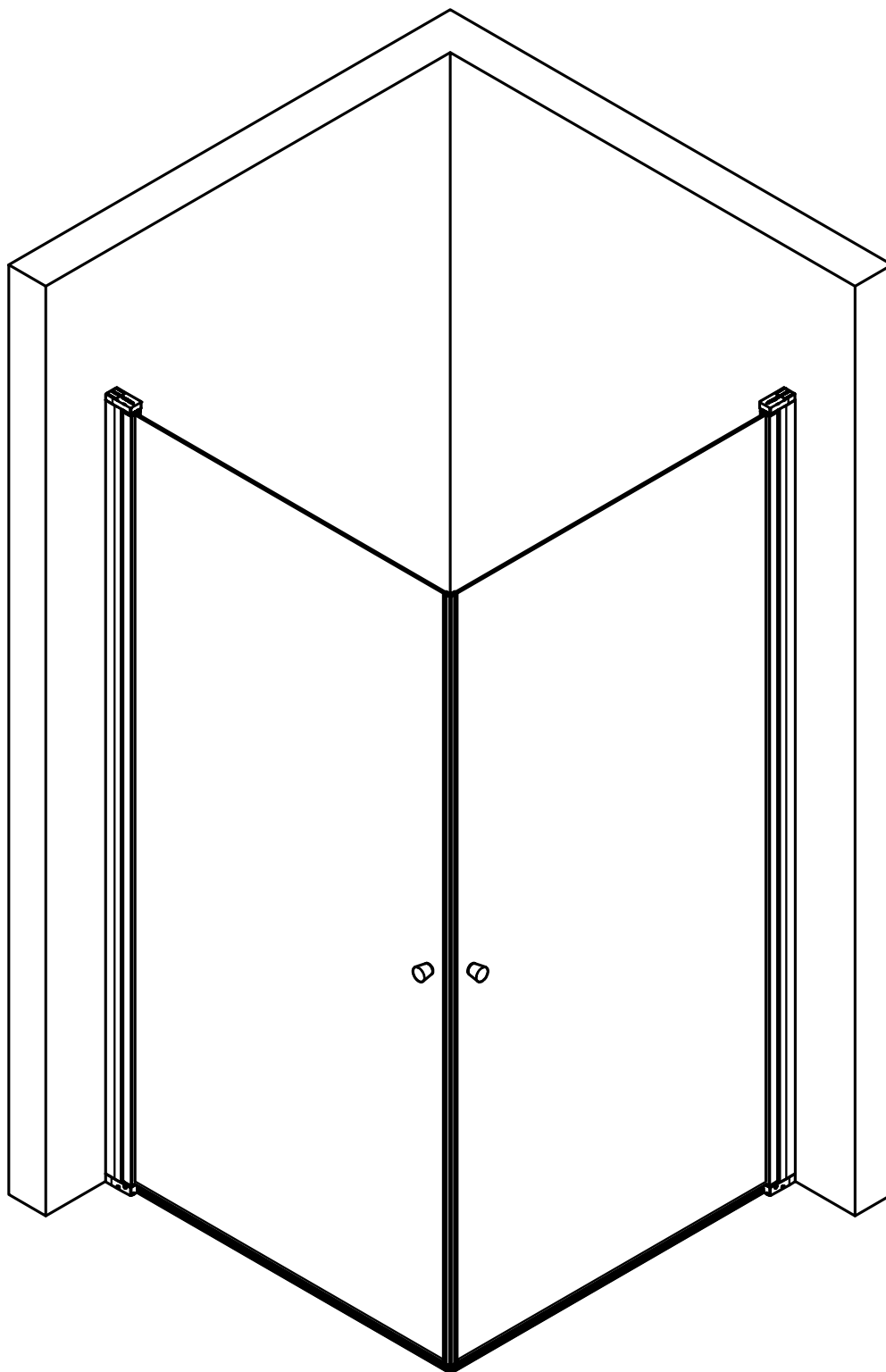

VIKINGBAD

Versjon 1.4.2021

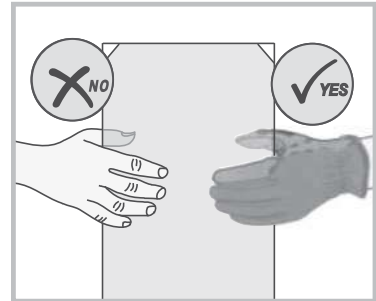
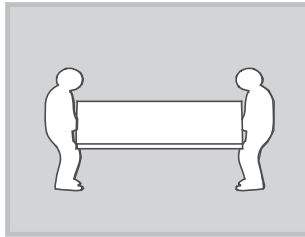
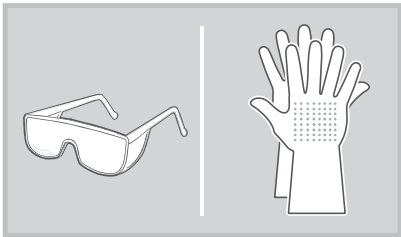
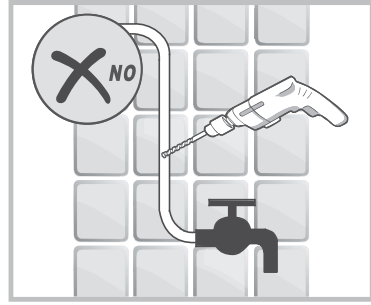
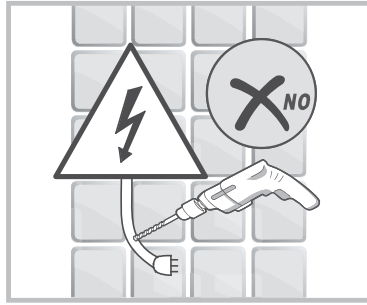
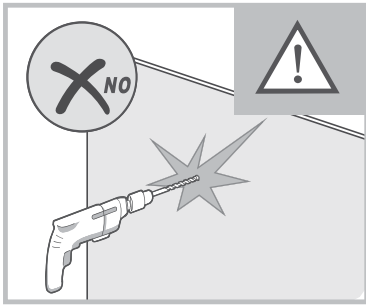

Liam dusjdør skal monteres på ett fast underlag og kan ikke henges på vegg uten understøttet bunn hengsle.

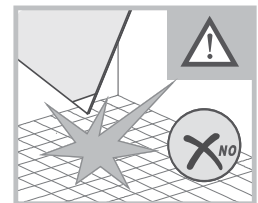
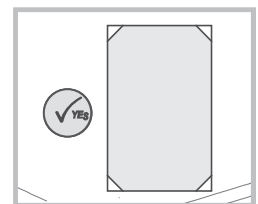
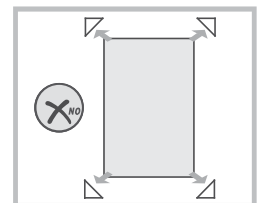
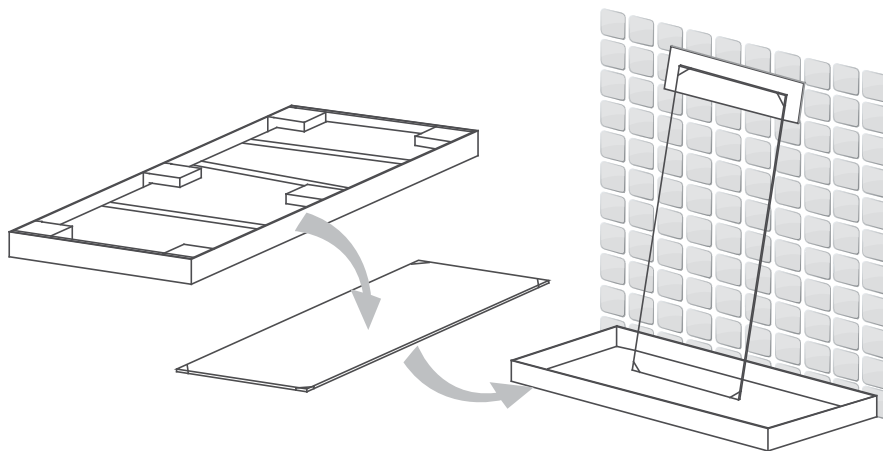
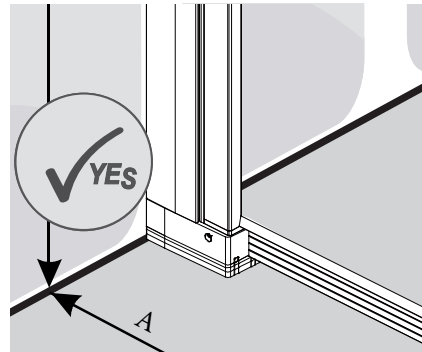
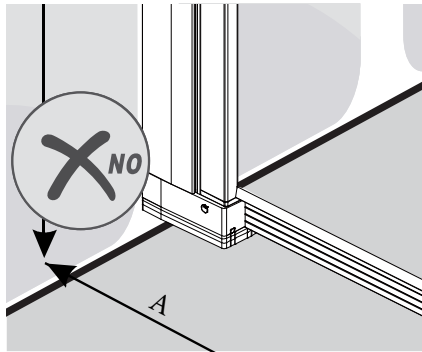

# Gjennomføring av utenpåliggende rør

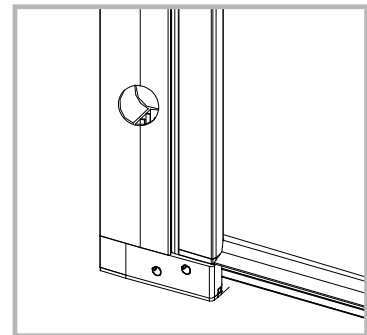
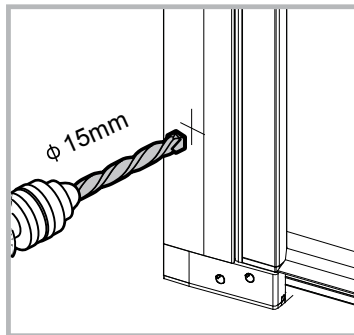
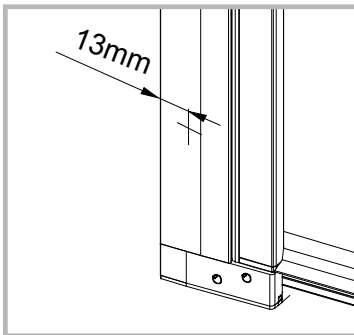
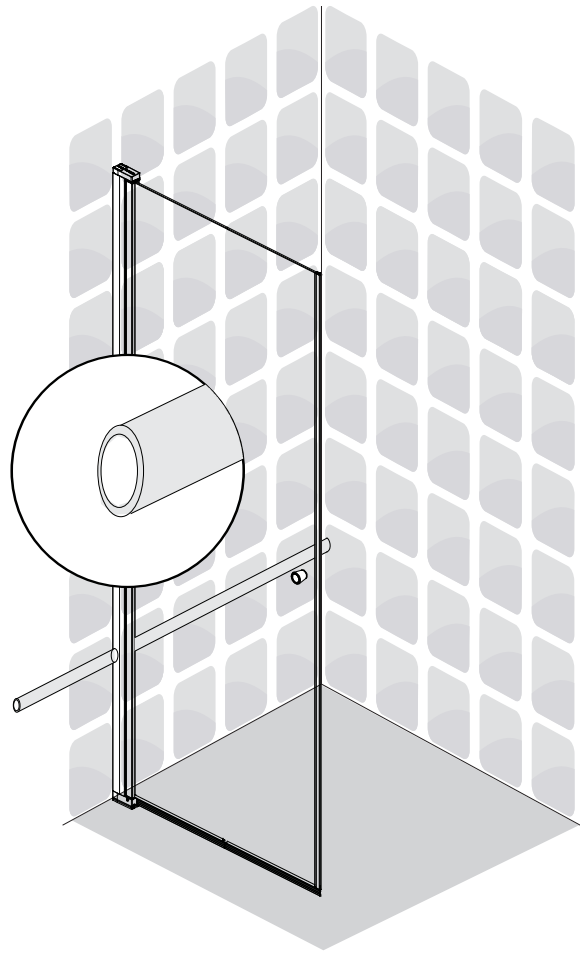

# Installasjon i nedsenket dusjsone

NB: Kontroller mål for dusjsonen før utforming, for å sikre at dusjsonen passer til planlagt løsning. Se tabeller for veiledende mål.

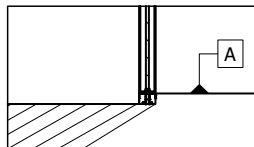
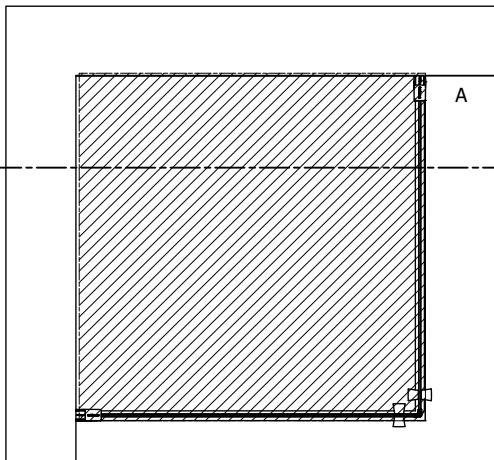

I nedsenket dusjsone

Dekker mål			Original veggprofil		+25mm utfellingsprofil		+50mm utfellingsprofil	
min	max	Dør størrelse	Mål 1		Mål 1		Mål 1	
			Min	Max	Min	Max	Min	Max
585	660	60 cm	585	610	610	635	635	660
685	760	70 cm	685	710	710	735	735	760
785	860	80 cm	785	810	810	835	835	860
885	960	90 cm	885	910	910	935	935	960
985	1060	100 cm	985	1010	1010	1035	1035	1060

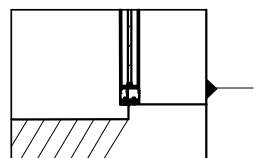
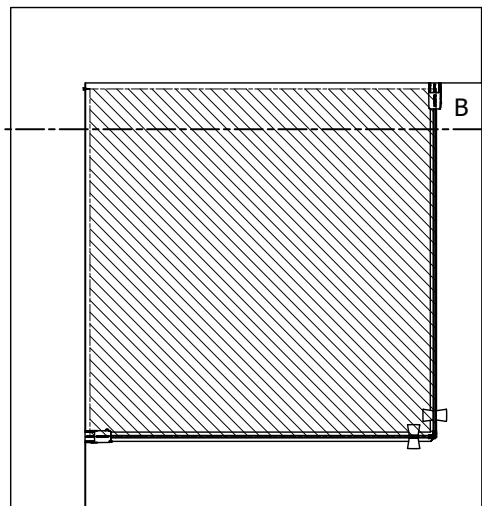

Innside av glass jevnt med dusjsone

Dekker mål			Original veggprofil		+25mm utfellingsprofil		+50mm utfellingsprofil	
min	max	Dør størrelse	Mål 1		Mål 1		Mål 1	
			Min	Max	Min	Max	Min	Max
565	640	60 cm	565	590	590	615	615	640
665	740	70 cm	665	690	690	715	715	740
765	840	80 cm	765	790	790	815	815	840
865	940	90 cm	865	890	890	915	915	940
965	1040	100 cm	965	990	990	1015	1015	1040

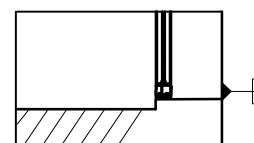
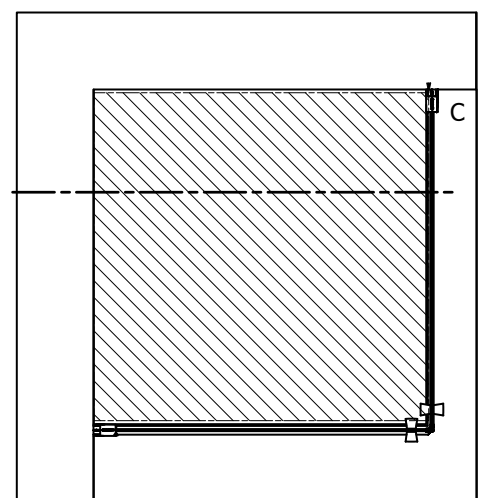

Utsiden av dusjsone

Dekker mål			Original veggprofil		+25mm utfellingsprofil		+50mm utfellingsprofil	
min	max	Dør størrelse	Mål 1		Mål 1		Mål 1	
			Min	Max	Min	Max	Min	Max
545	620	60 cm	545	570	570	595	595	620
645	720	70 cm	645	670	670	695	695	720
745	820	80 cm	745	770	770	795	795	820
845	920	90 cm	845	870	870	895	895	920
945	1020	100 cm	945	970	970	995	995	1020

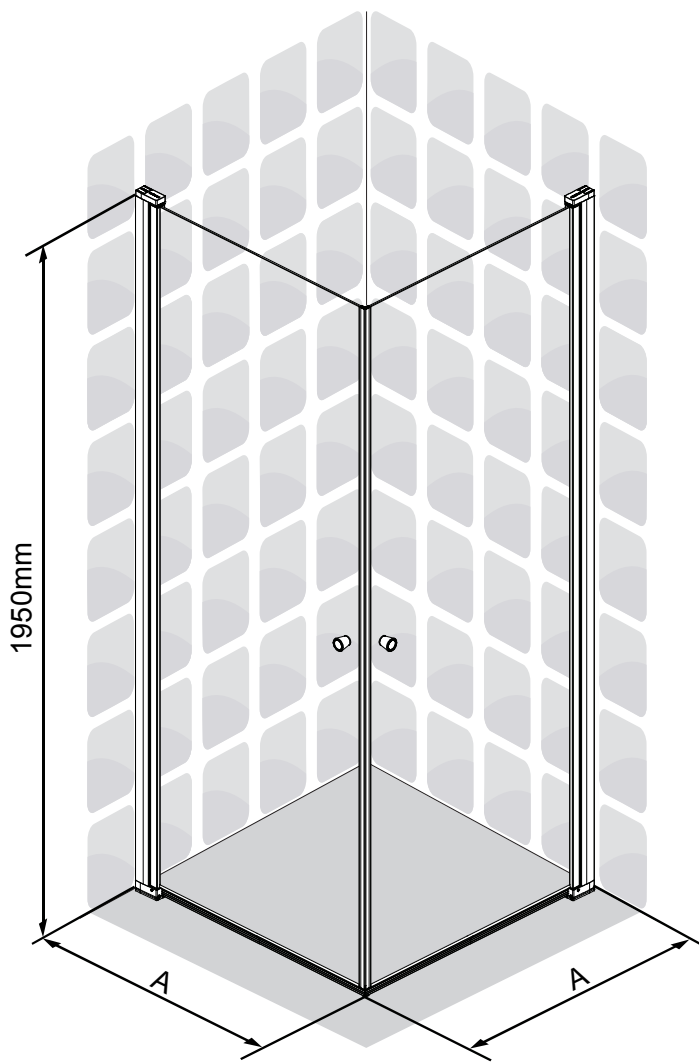
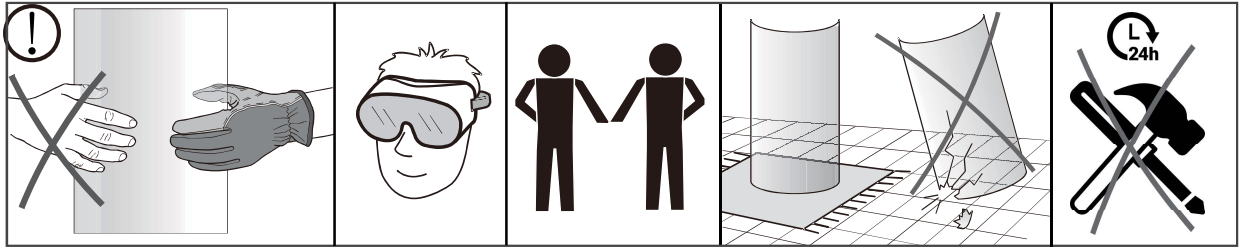

A	Min	Max
600	585	610
700	685	710
800	785	810
900	885	910
1000	985	1010

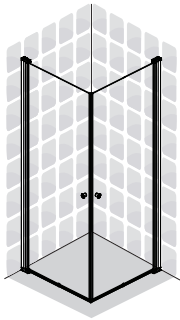

CTN1/2

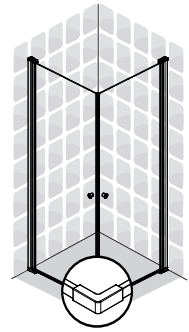
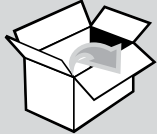

CTN1/2/3



CTN1

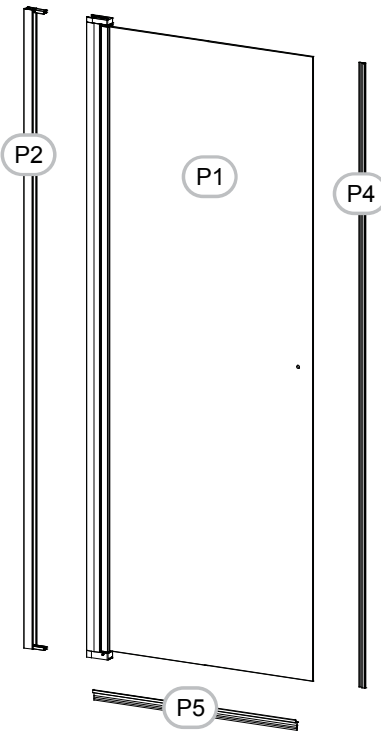
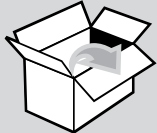

CTN2

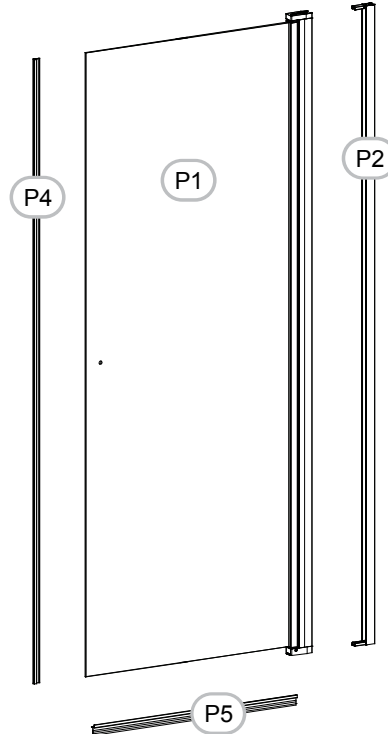
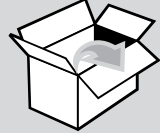

CTN3

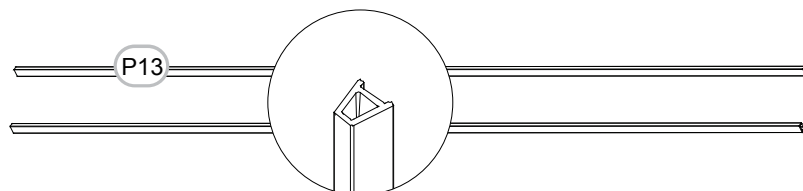
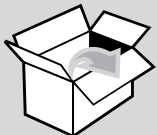

CTN1/2

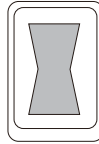
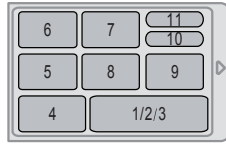
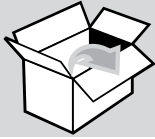

1

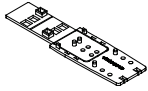

2mm

x1

2

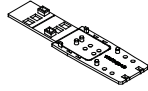

3mm

x1

3

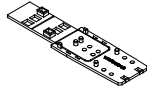

4mm

x1

4

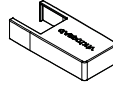

x1

5



x4

6



x4

7



x4

8



x4+2

9



x1

10

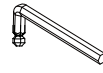

2.5mm

x1

11

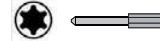

x1

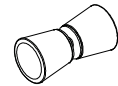

x1

CTN3

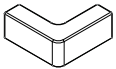
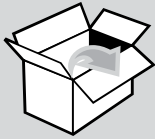

x1

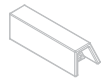

x1



x1



x1

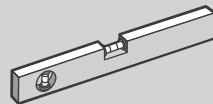
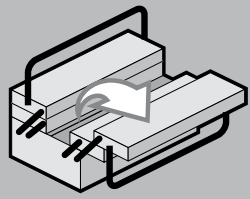

Ø6mm

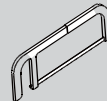
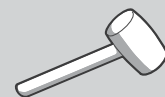
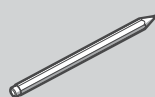
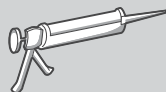

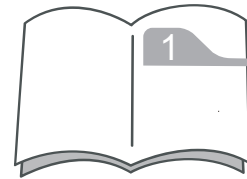
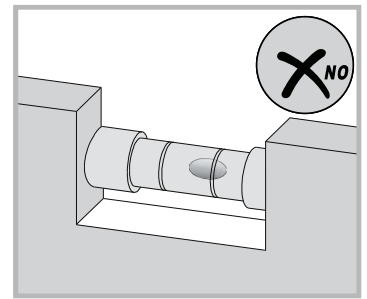
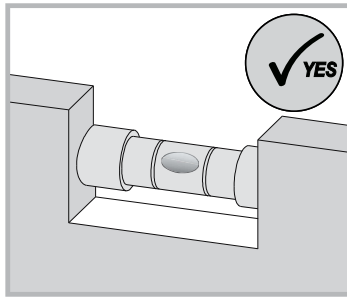
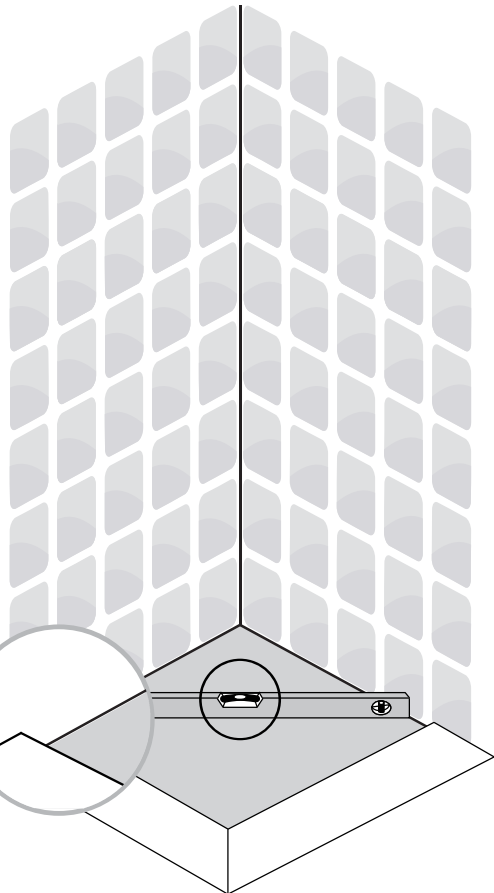
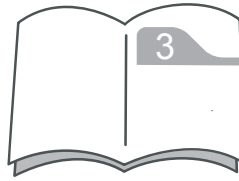
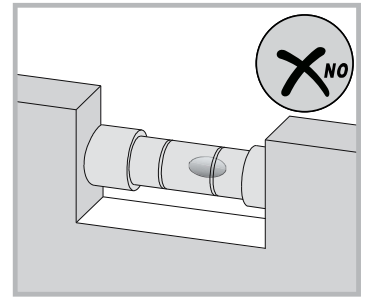
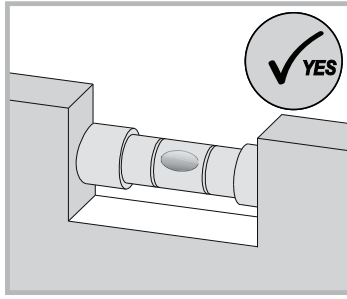
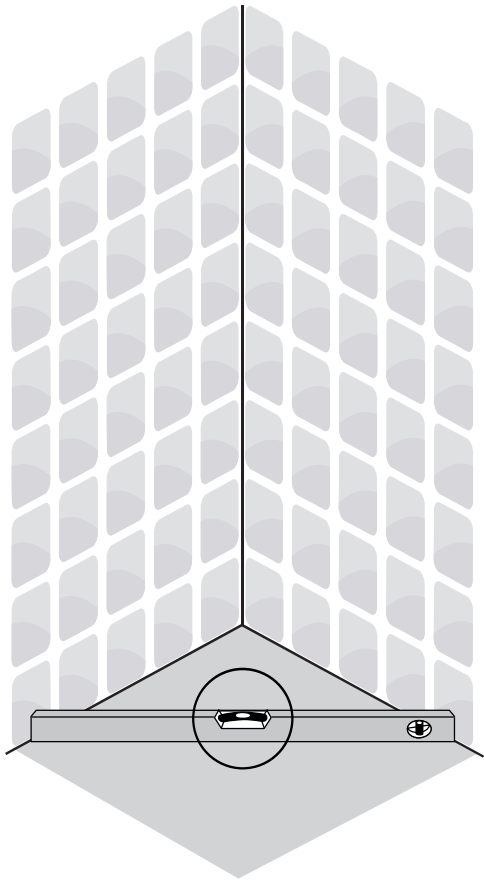



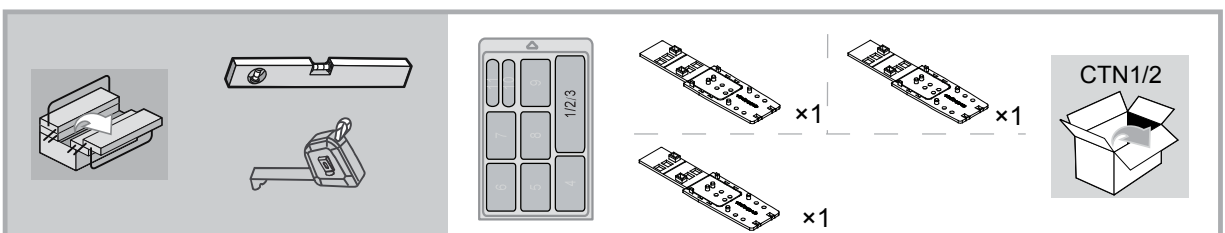
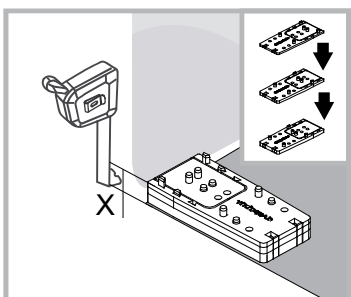
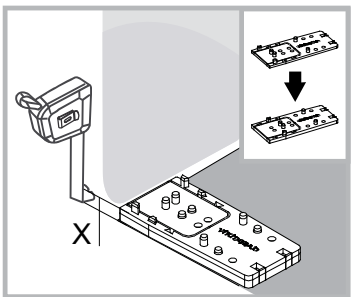
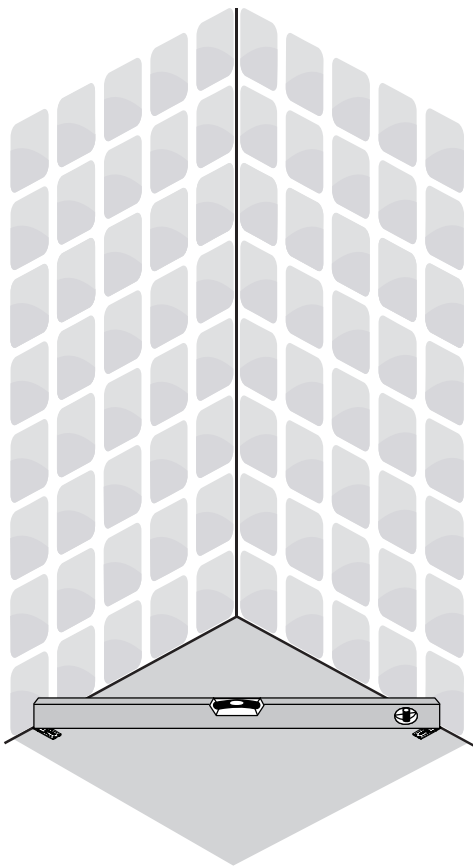
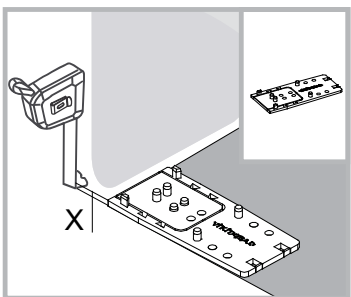
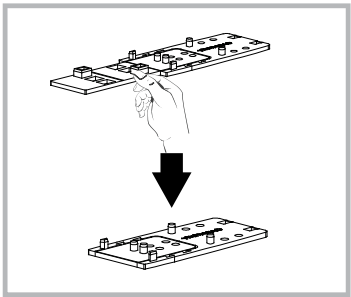
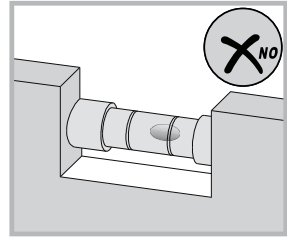
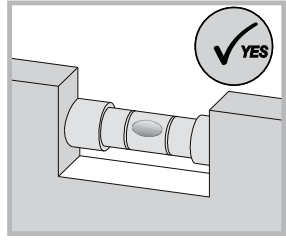
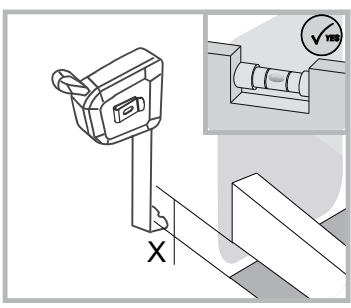

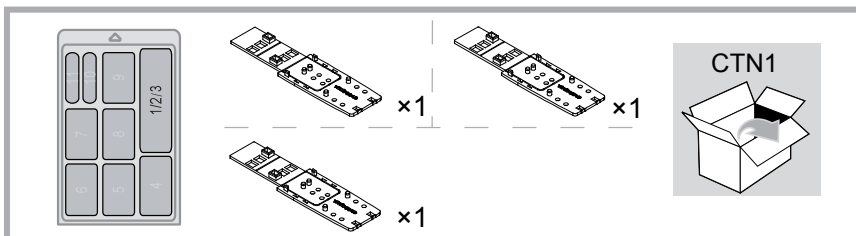
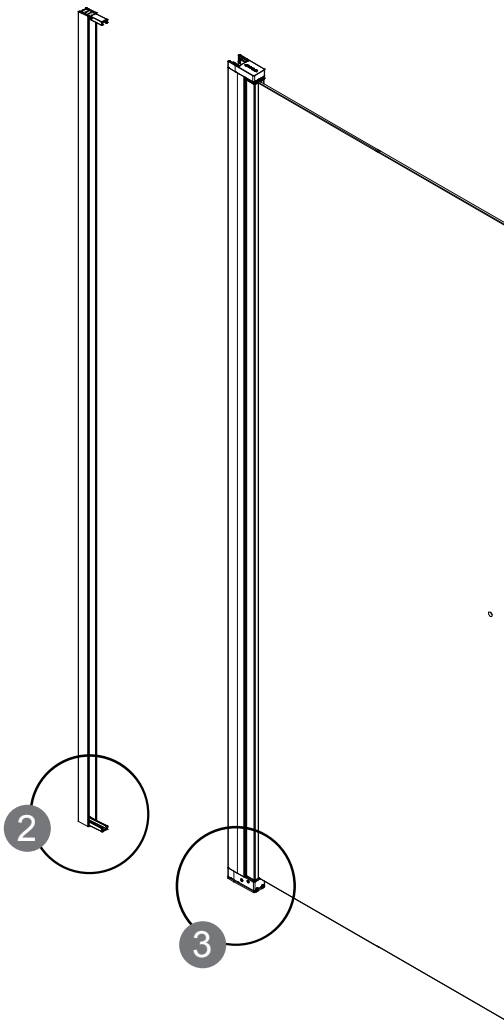
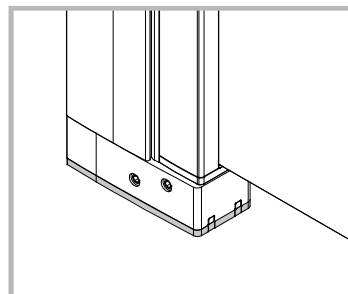
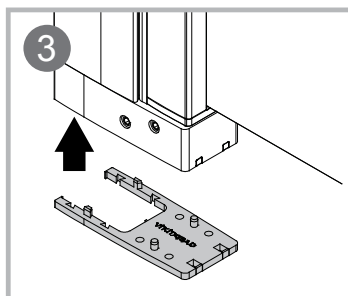
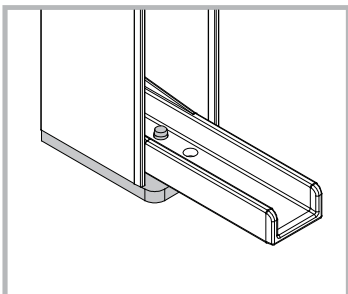
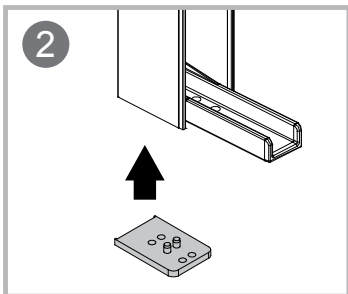
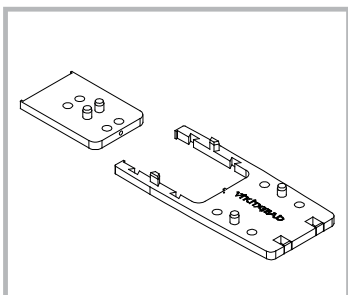
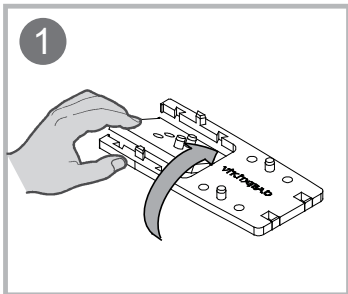

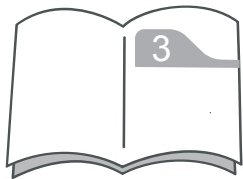
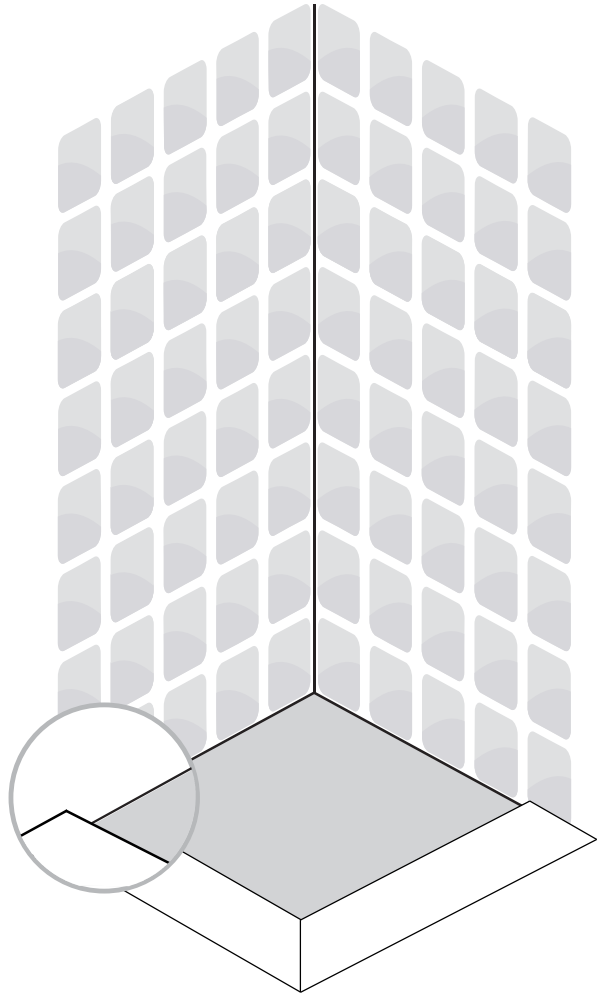
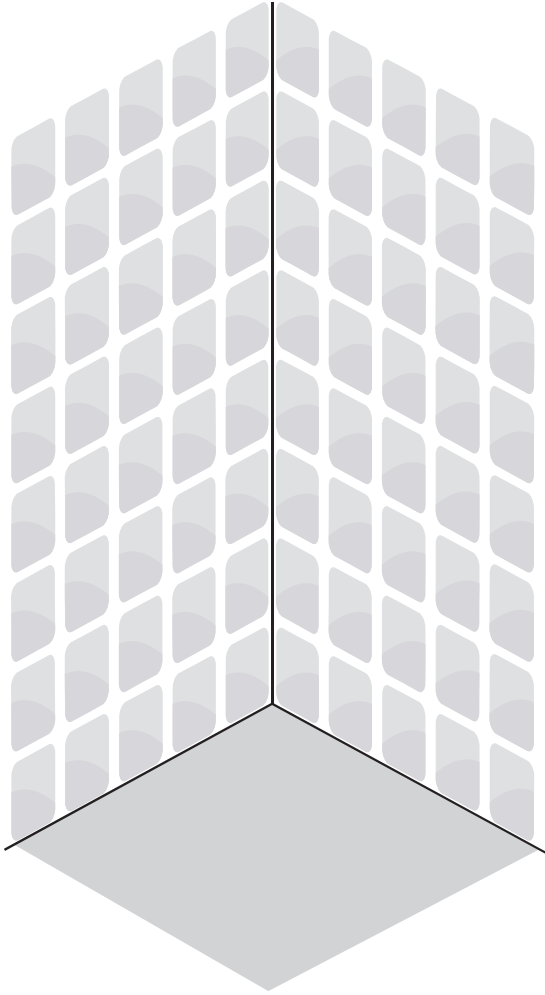

3

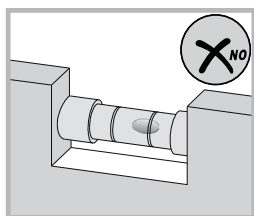
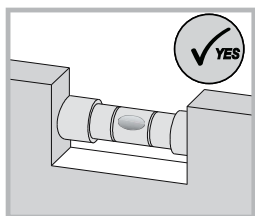

A	Yttermål ferdig montert		Yttermål veggprofil	
	Min	Max	Min	Max
600	585	610	581	606
700	685	710	681	706
800	785	810	781	806
900	885	910	881	906
1000	985	1010	981	1006

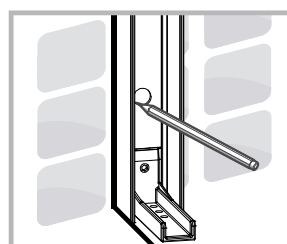
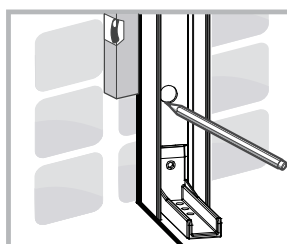
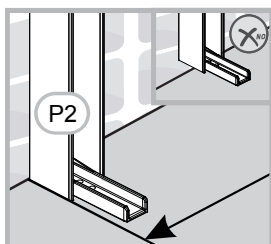
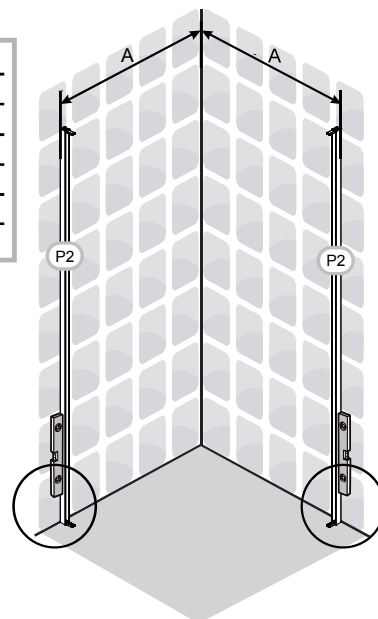

P2  $\longleftrightarrow$   $\times 2$

4

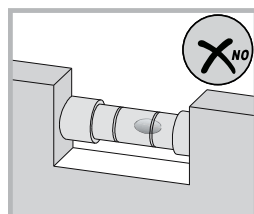
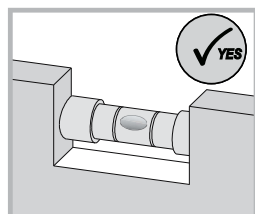

A	Yttermål ferdig montert		Yttermål veggprofil	
	Min	Max	Min	Max
600	585	610	581	606
700	685	710	681	706
800	785	810	781	806
900	885	910	881	906
1000	985	1010	981	1006

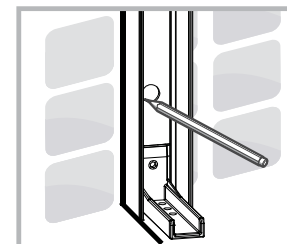
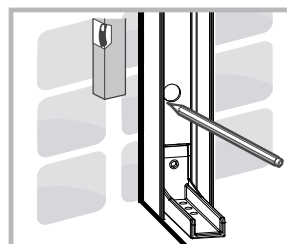
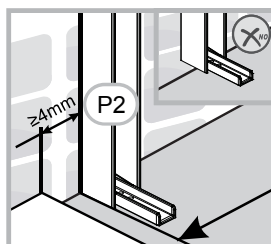
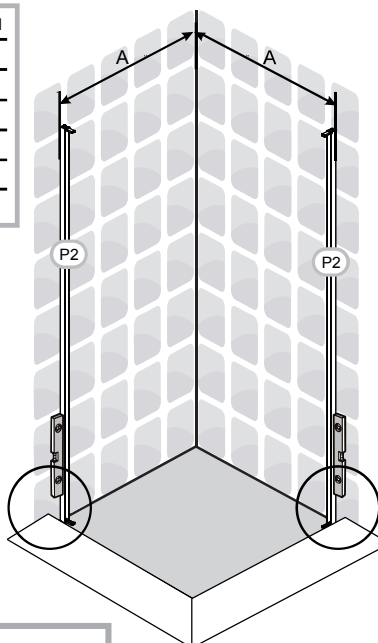

P2  $\longleftrightarrow$   $\times 2$

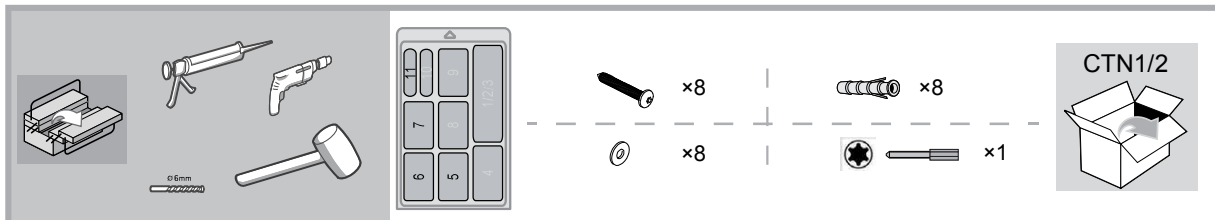
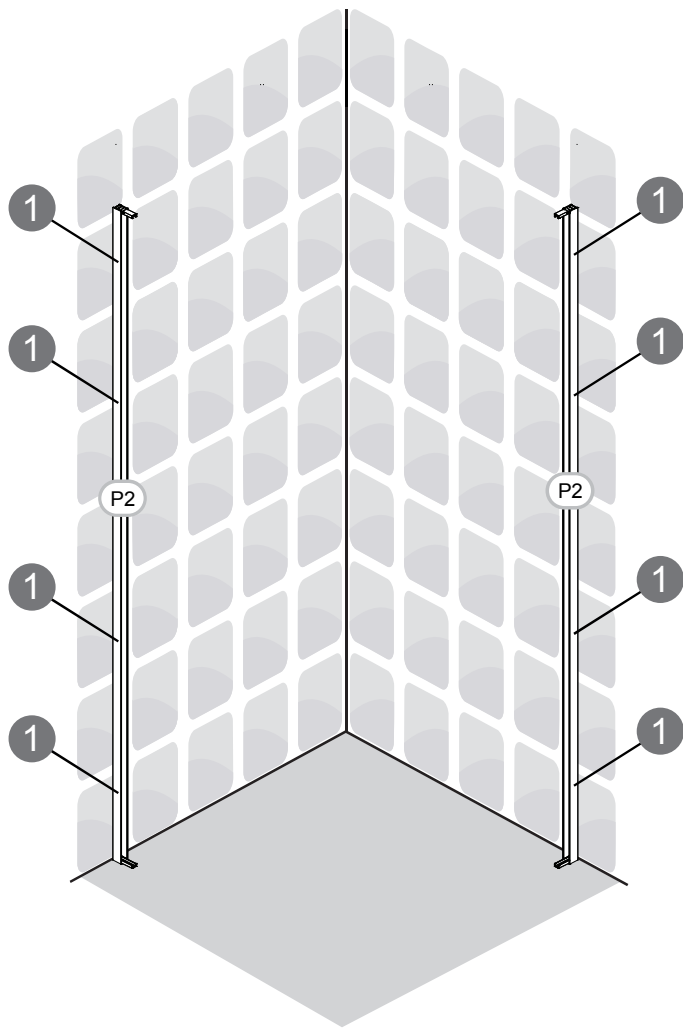
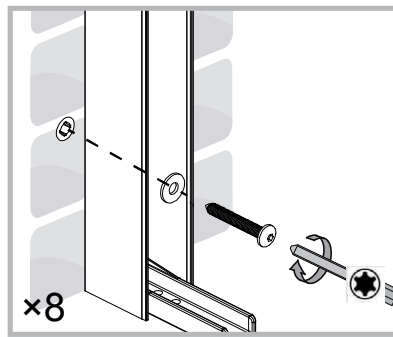
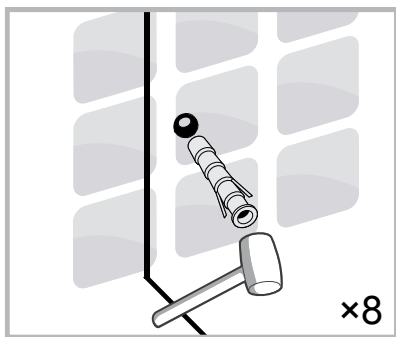
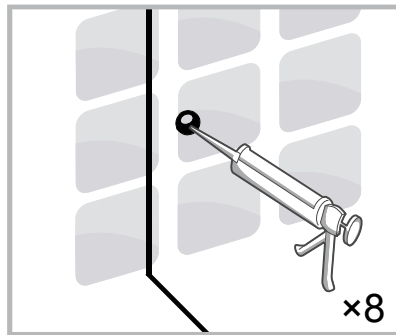
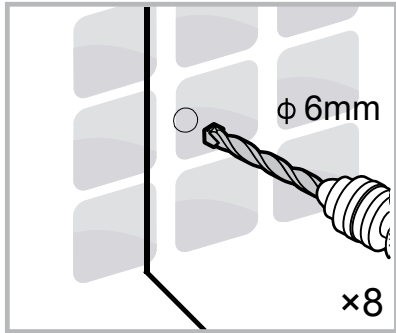

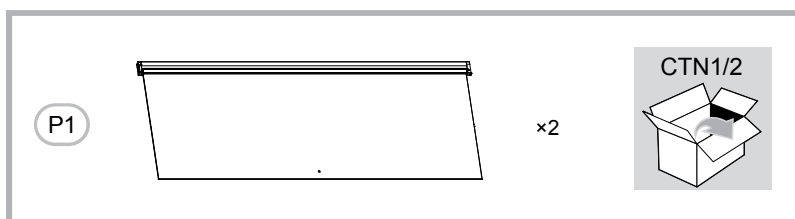
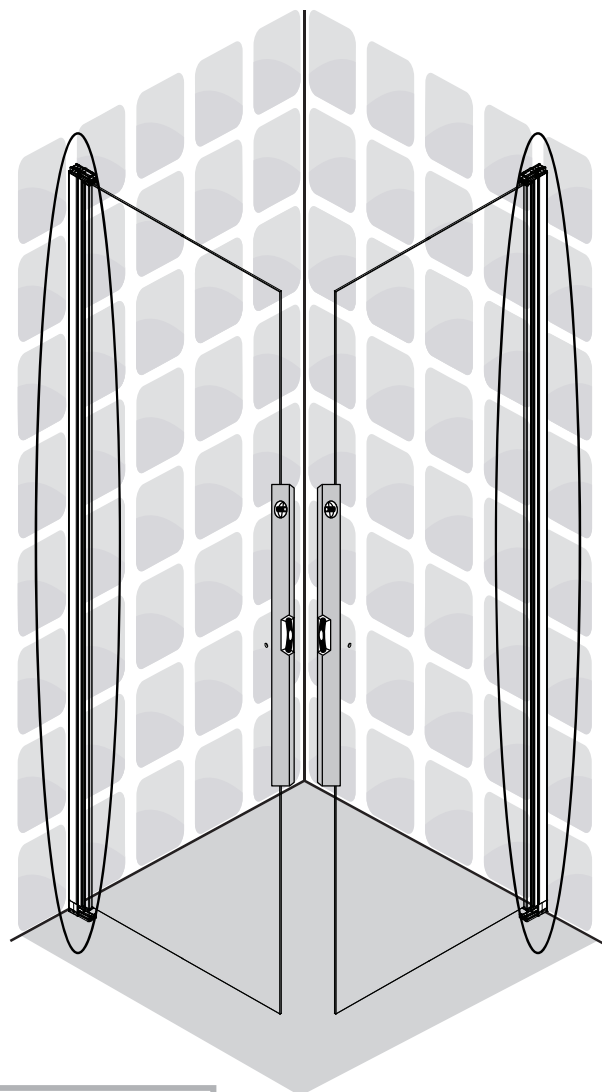
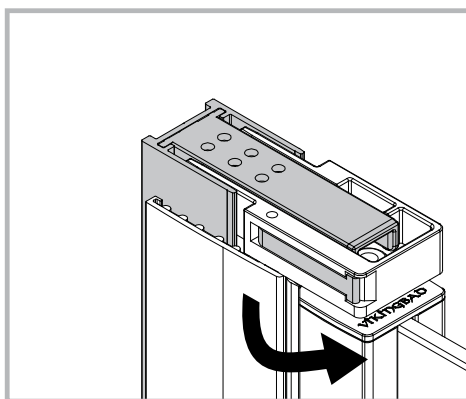
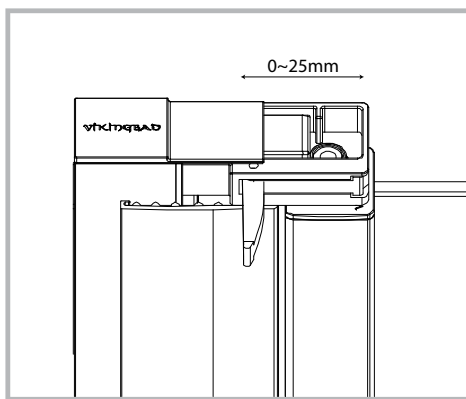
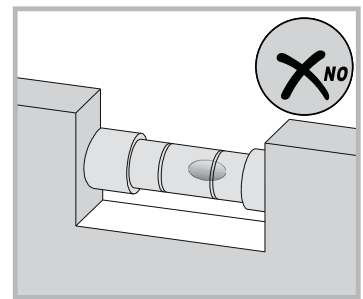
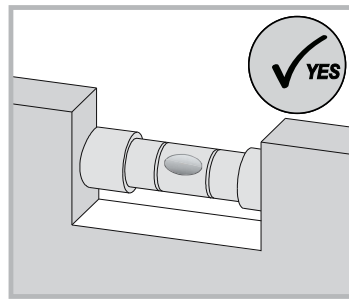
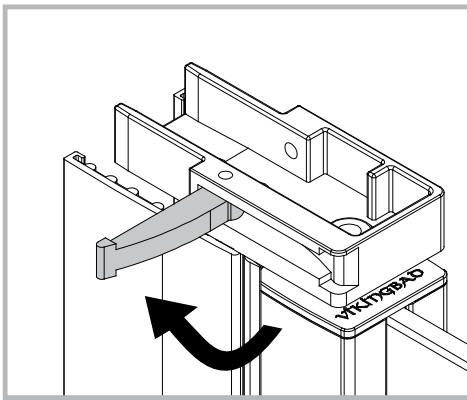

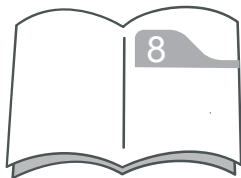
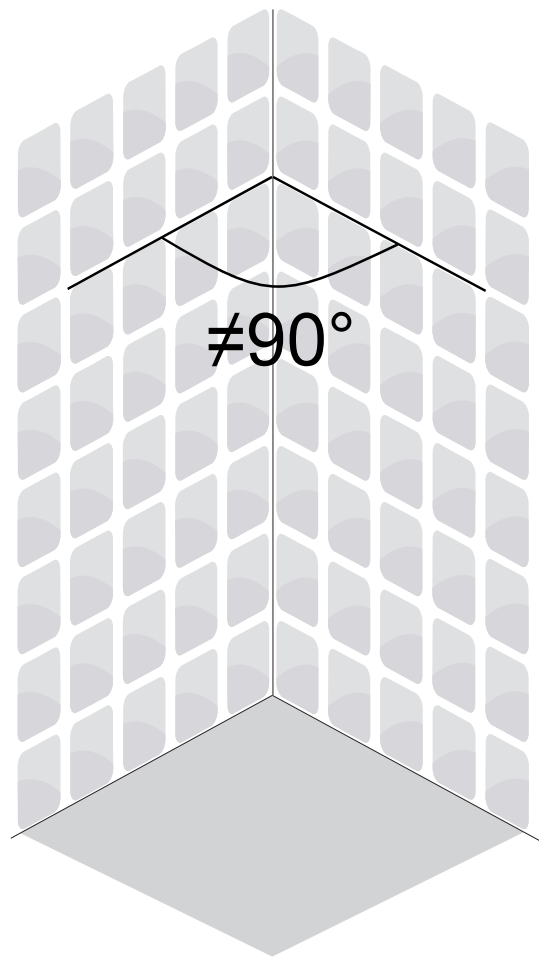
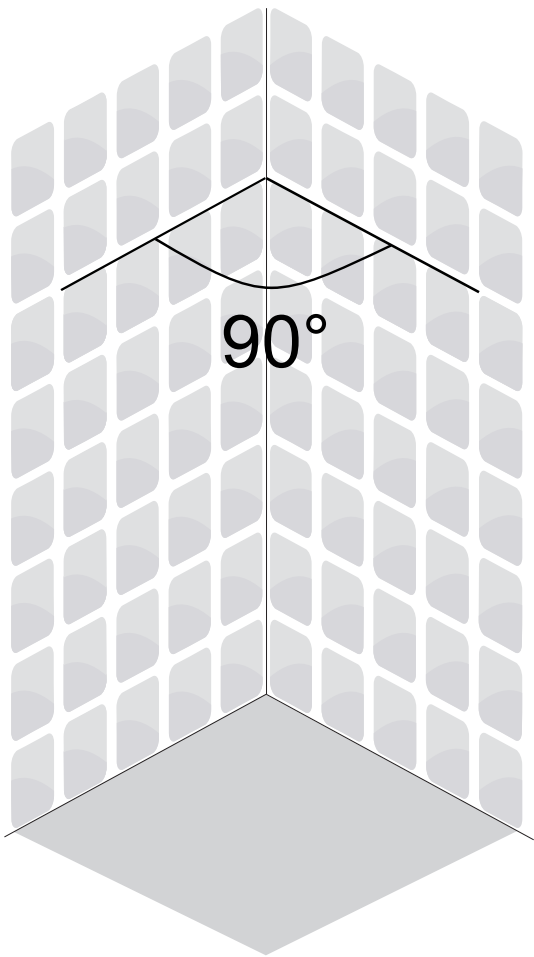

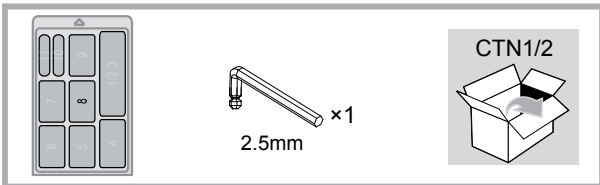
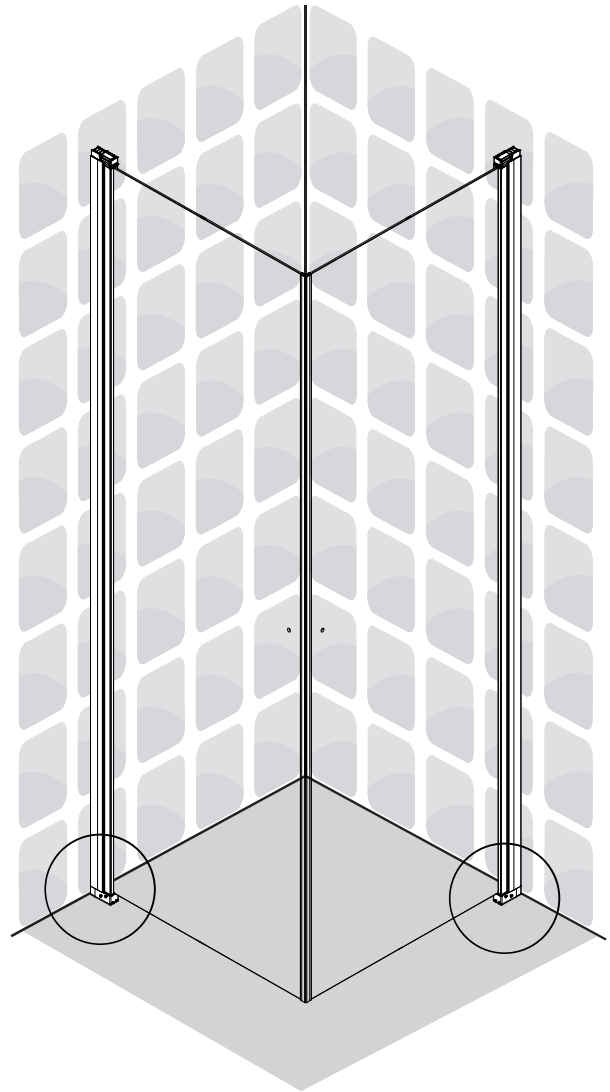
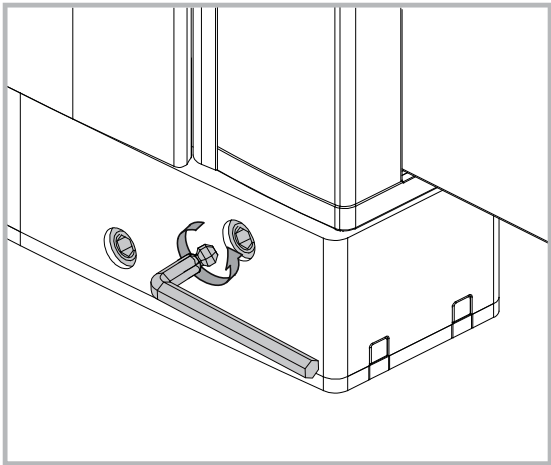
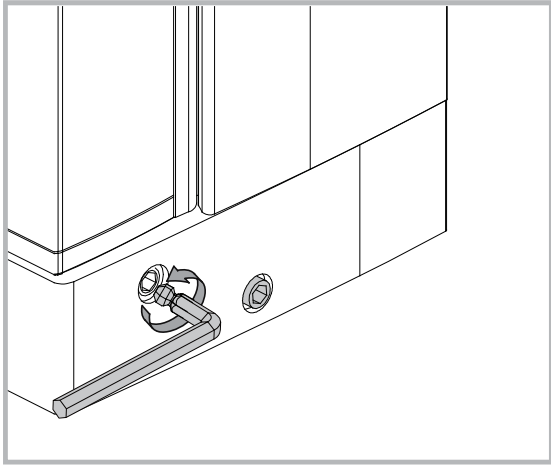



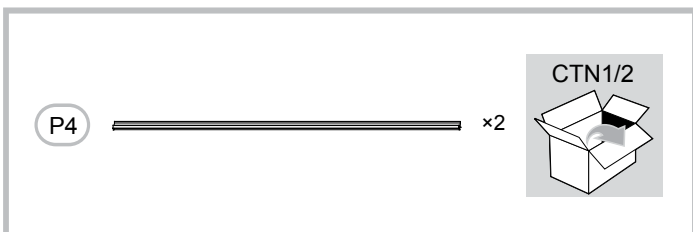
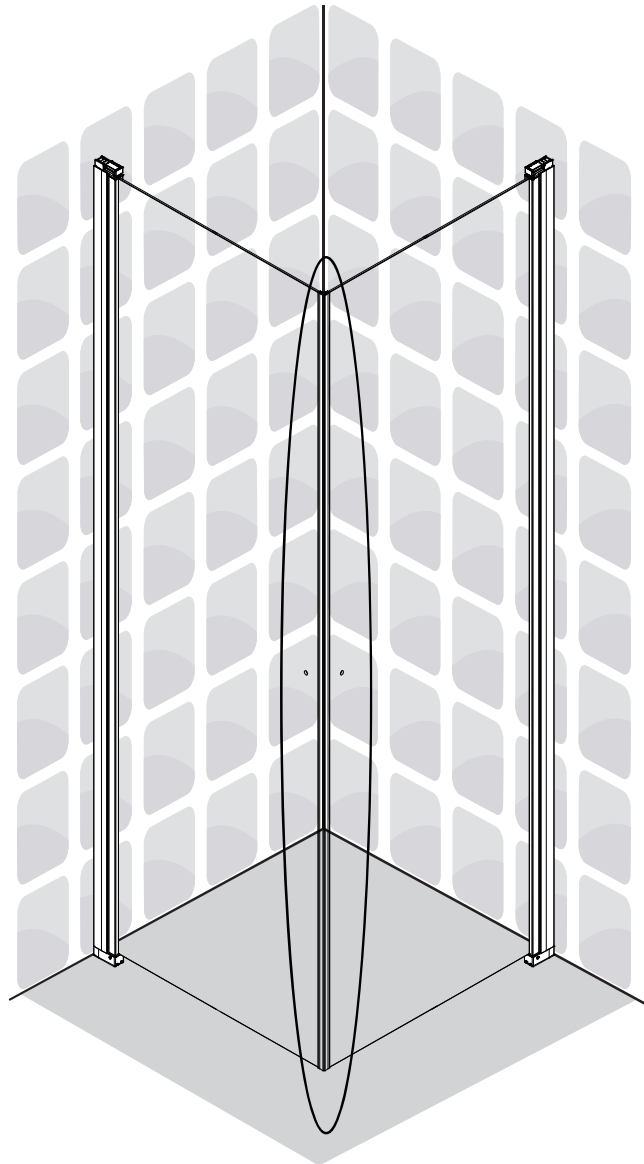
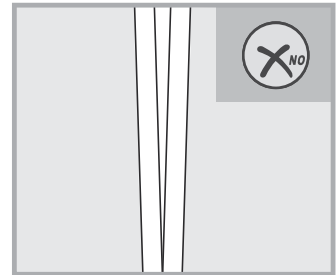
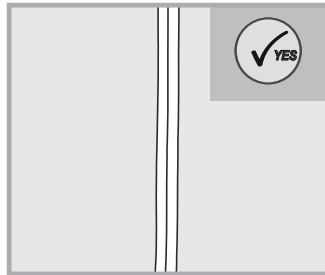
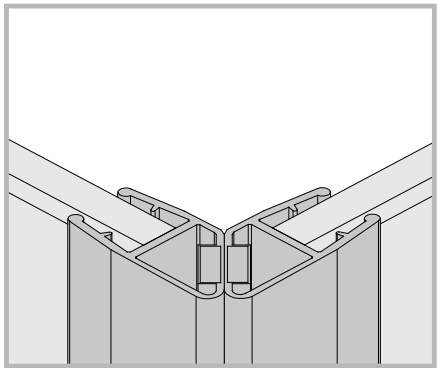
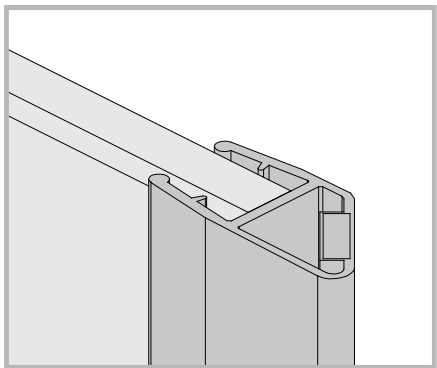
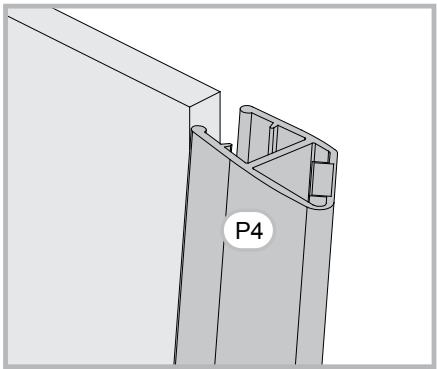

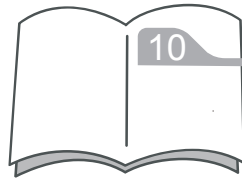
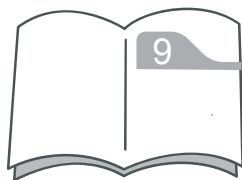
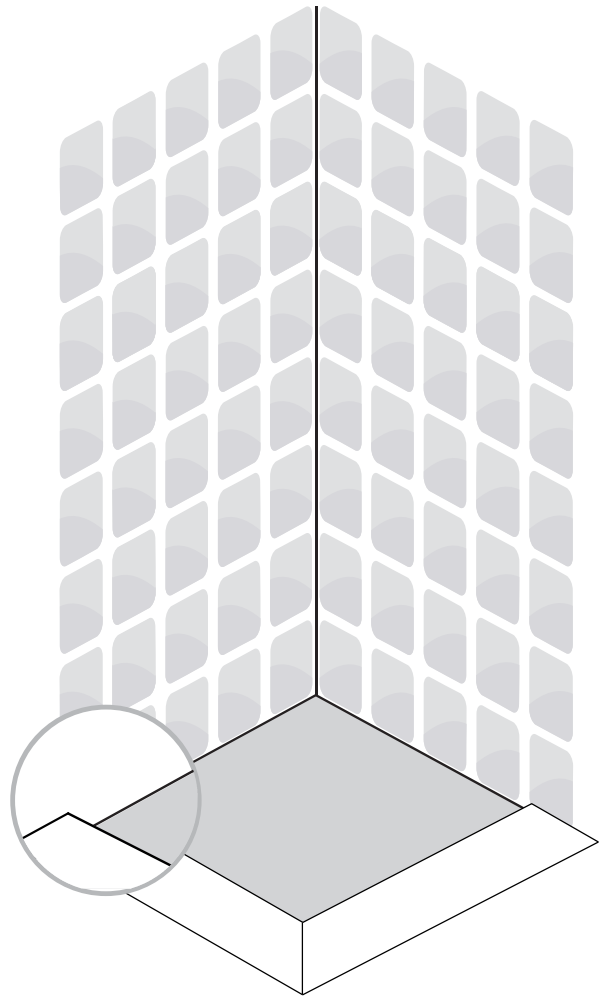
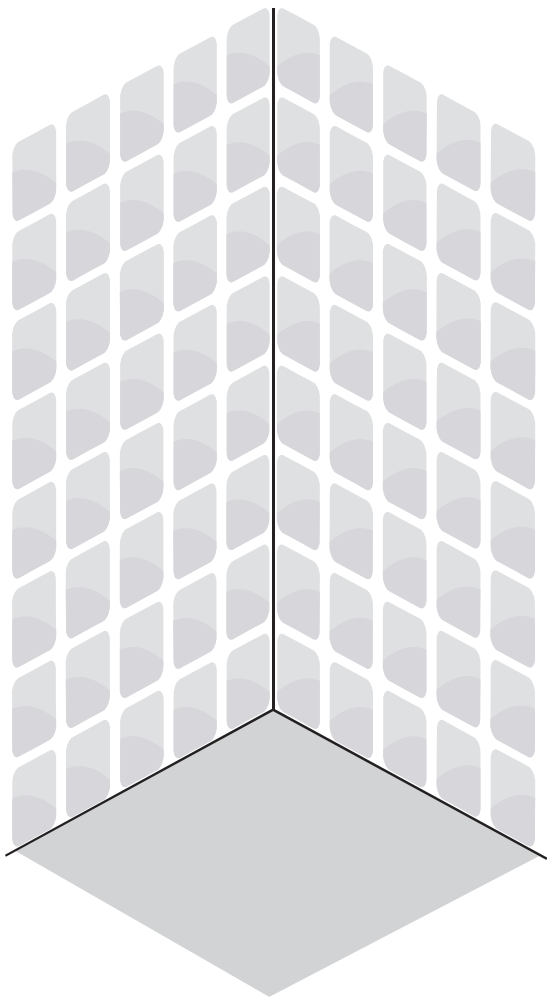

9

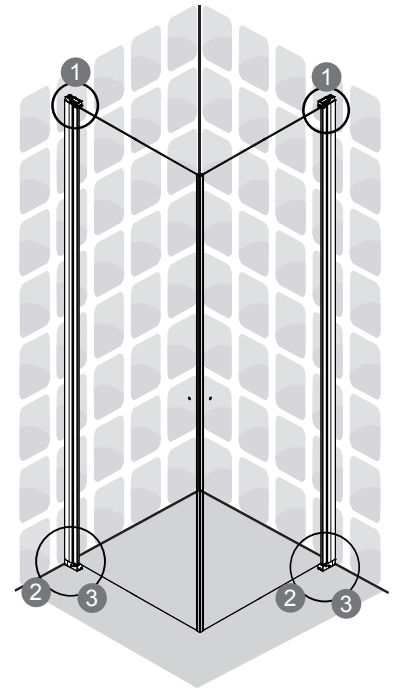
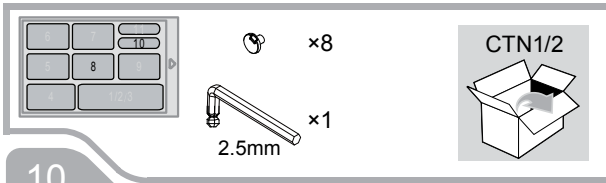
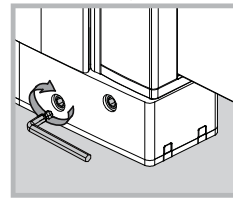
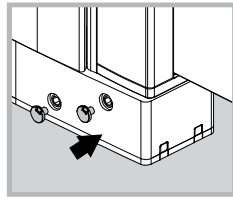
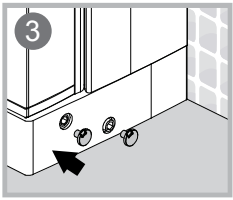
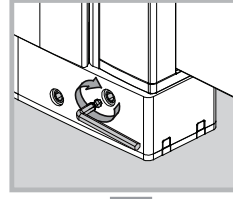
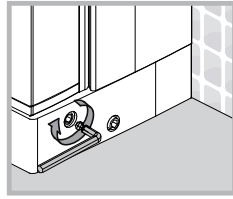
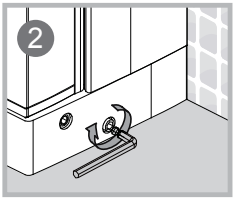
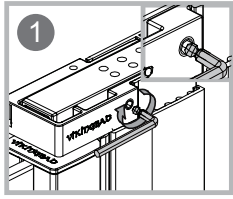

10

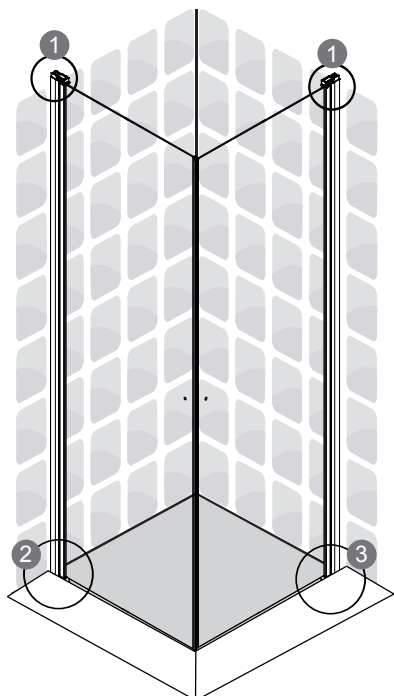
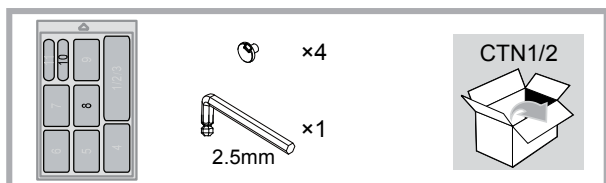
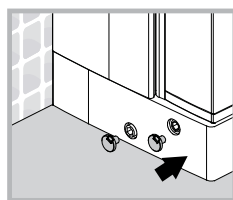
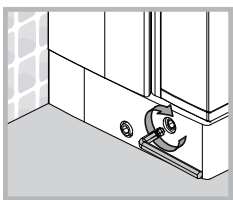
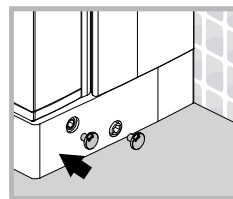
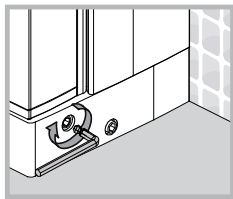
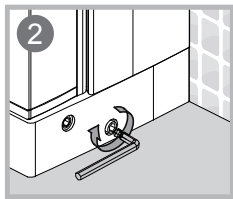
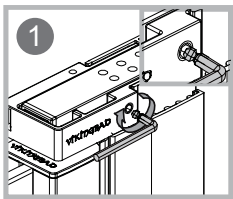

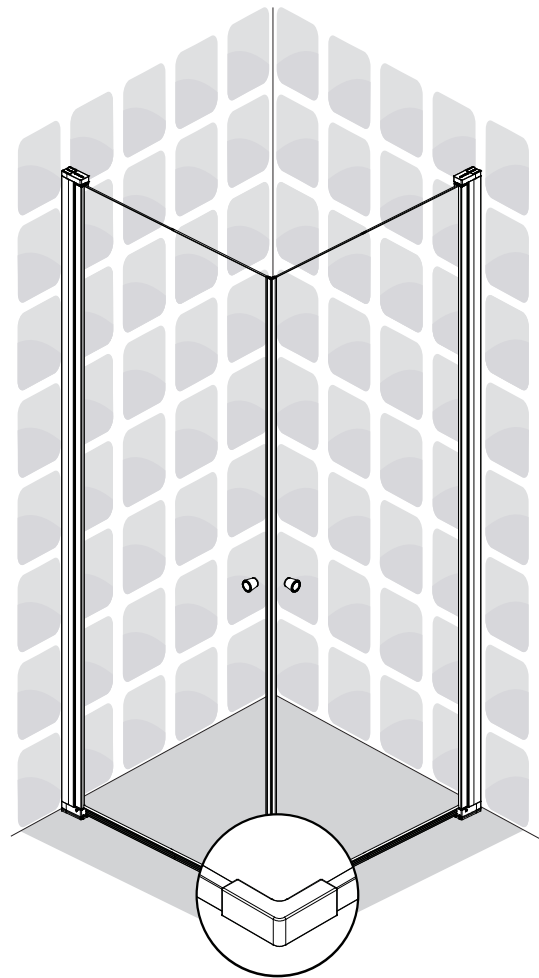
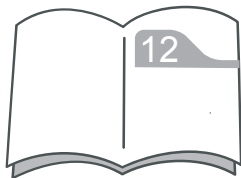
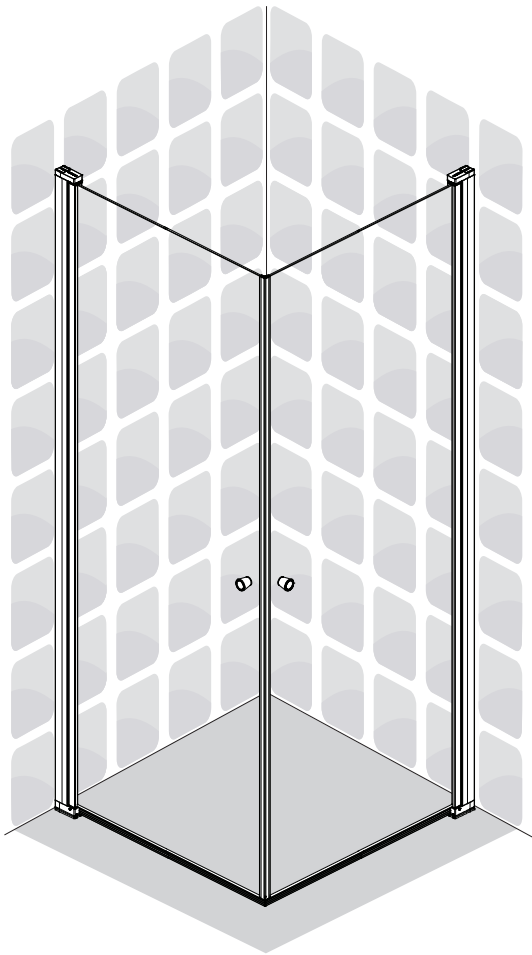

11

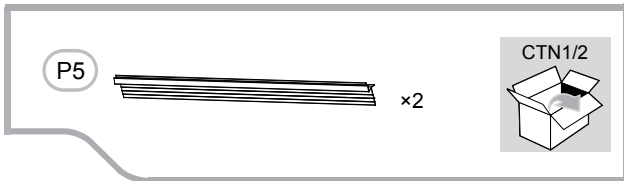
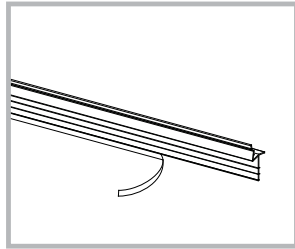
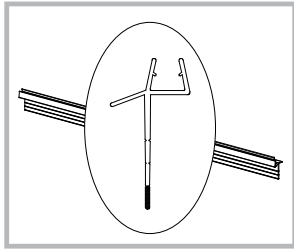

12

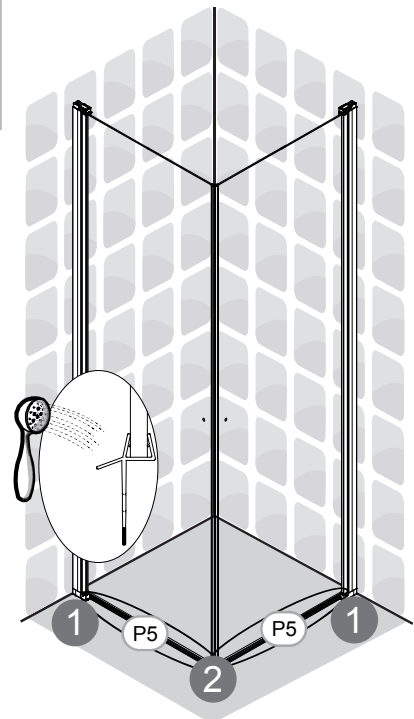
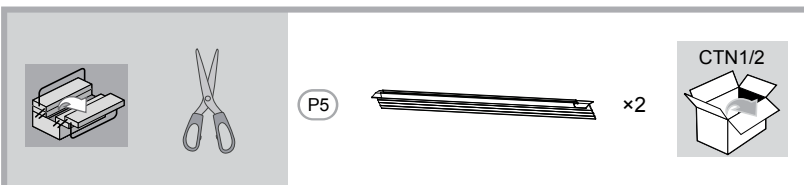
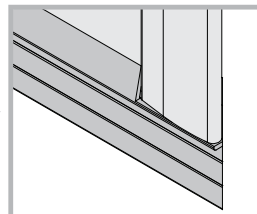
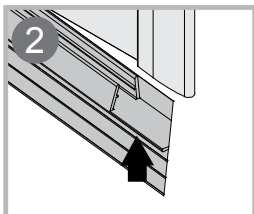
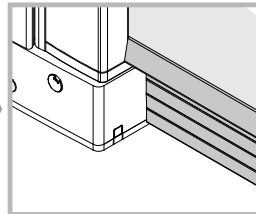
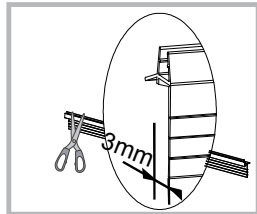
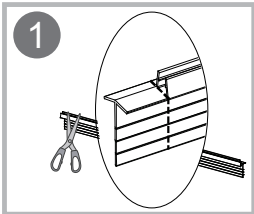

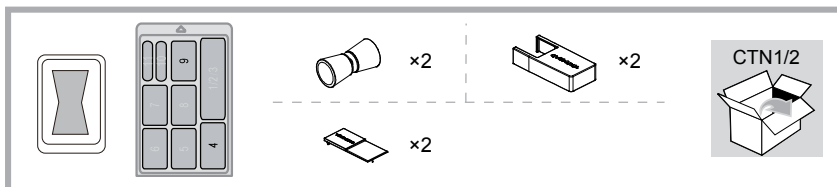
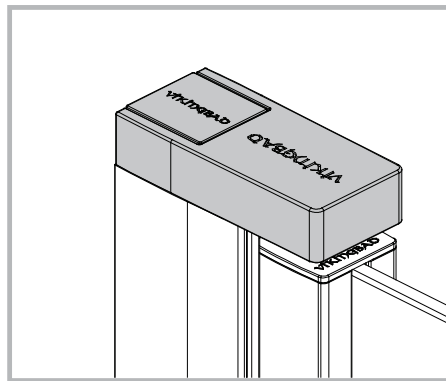
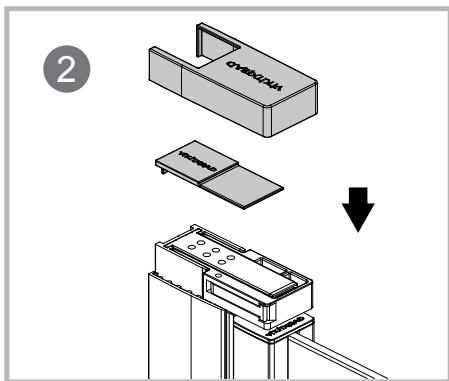
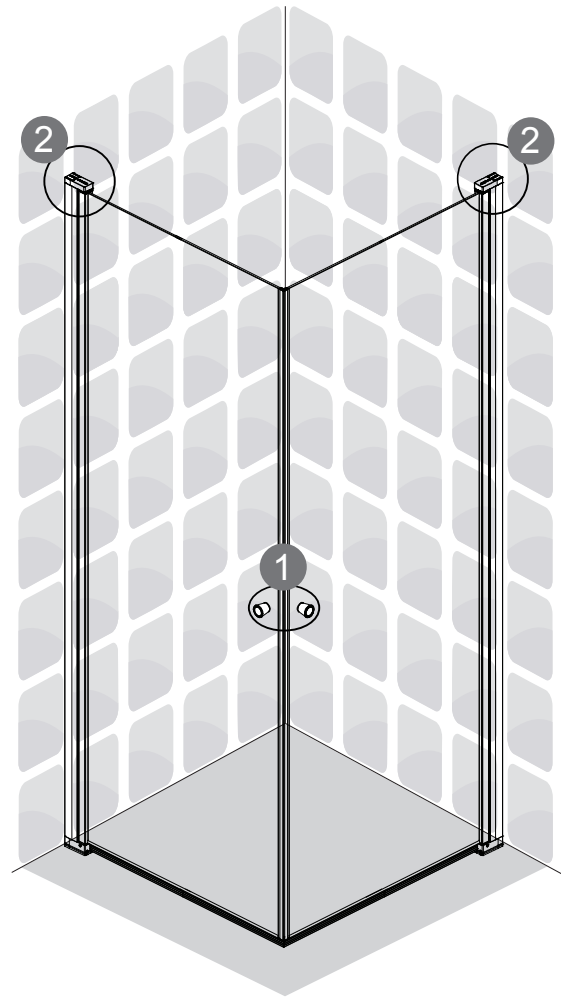
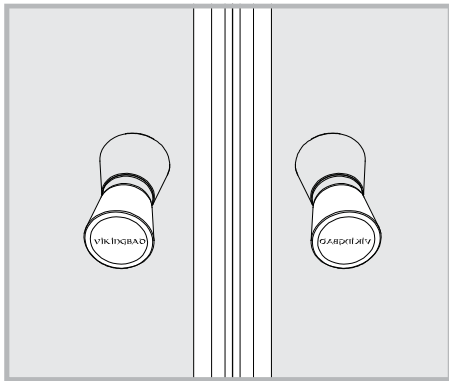
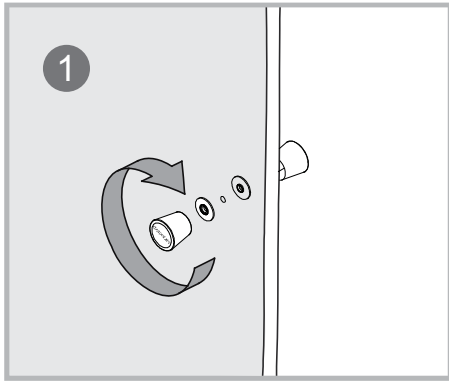

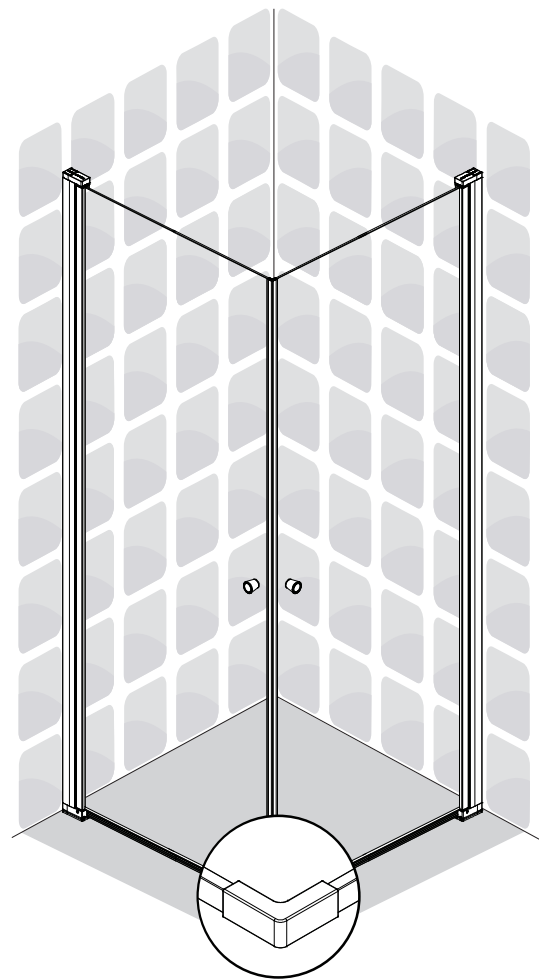
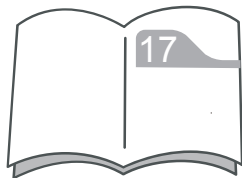
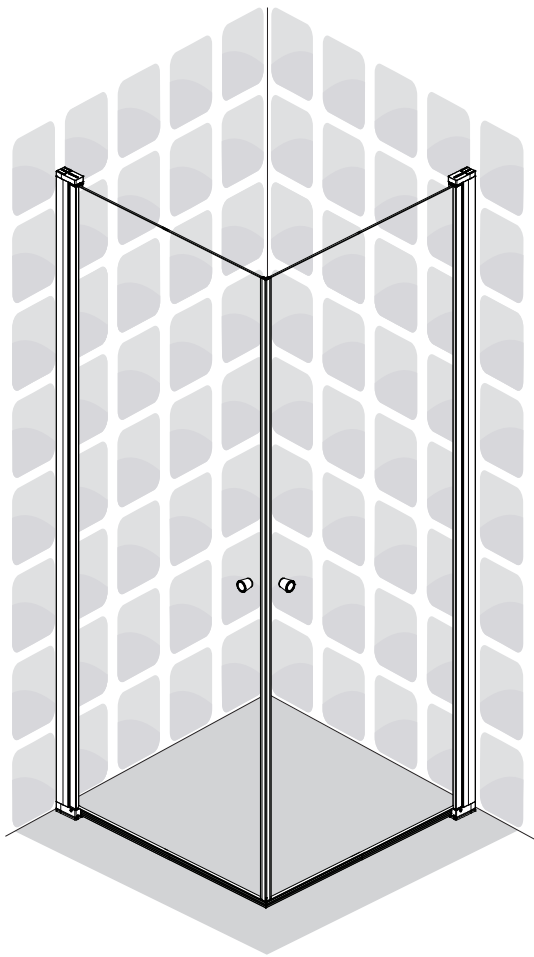

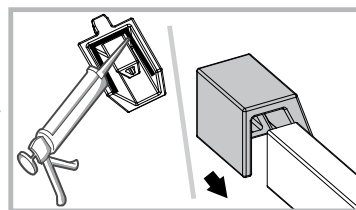
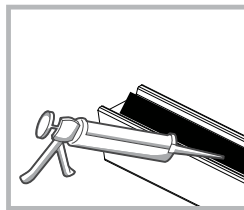
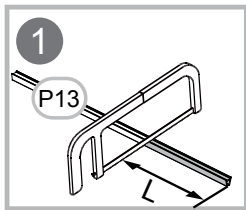
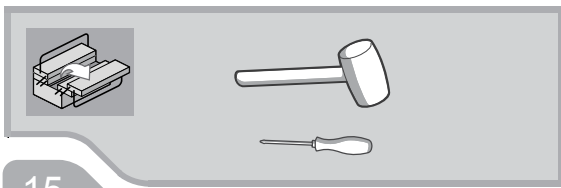
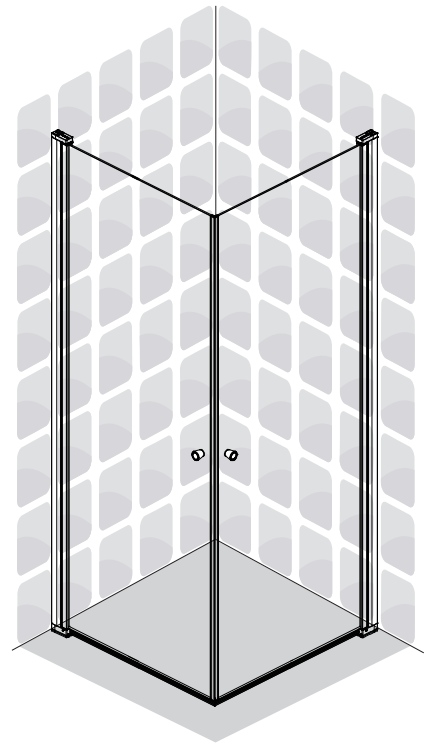
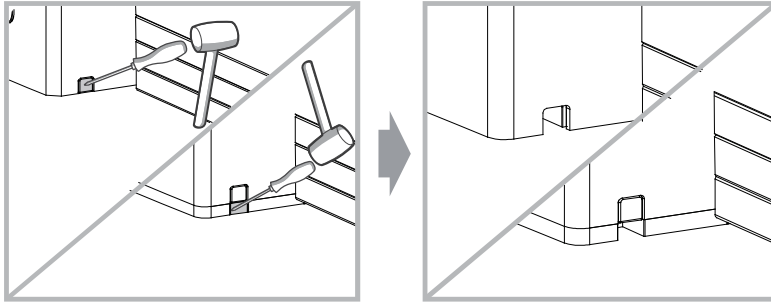

A	L
600	518
700	618
800	718
900	818
1000	918

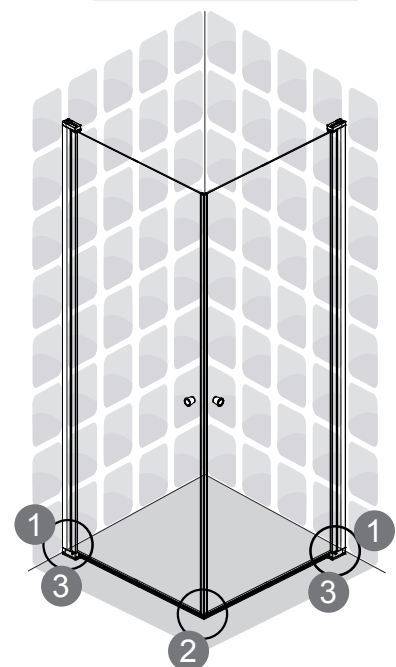
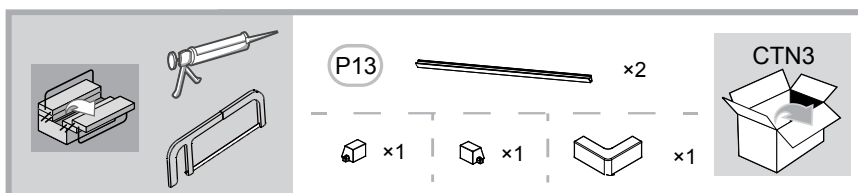
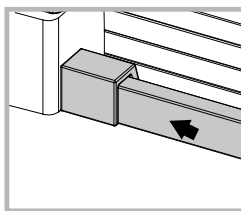
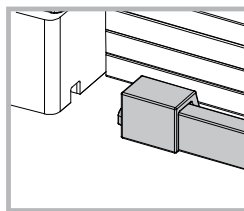
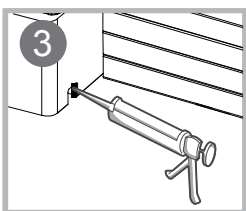
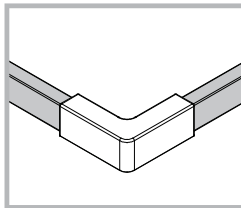
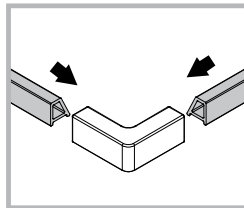
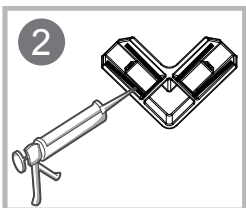



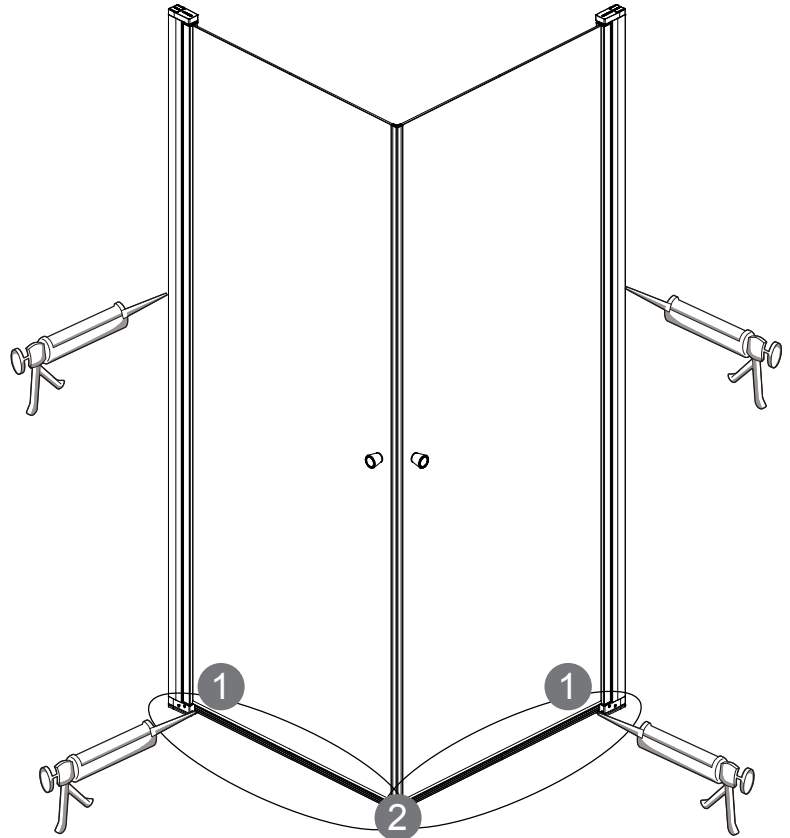
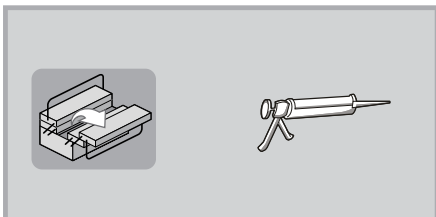
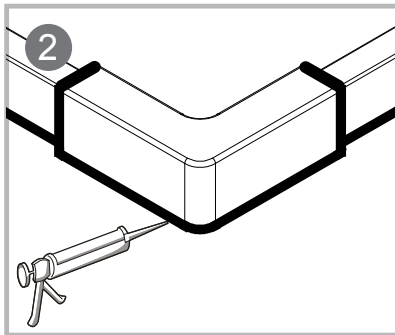
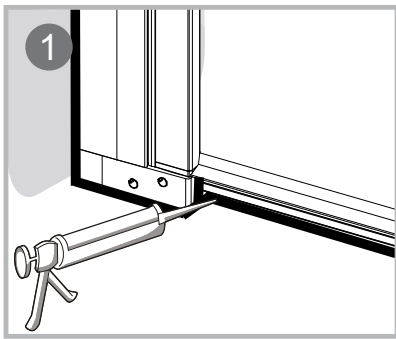
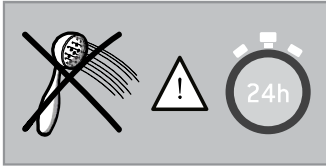

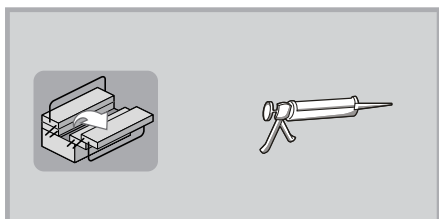
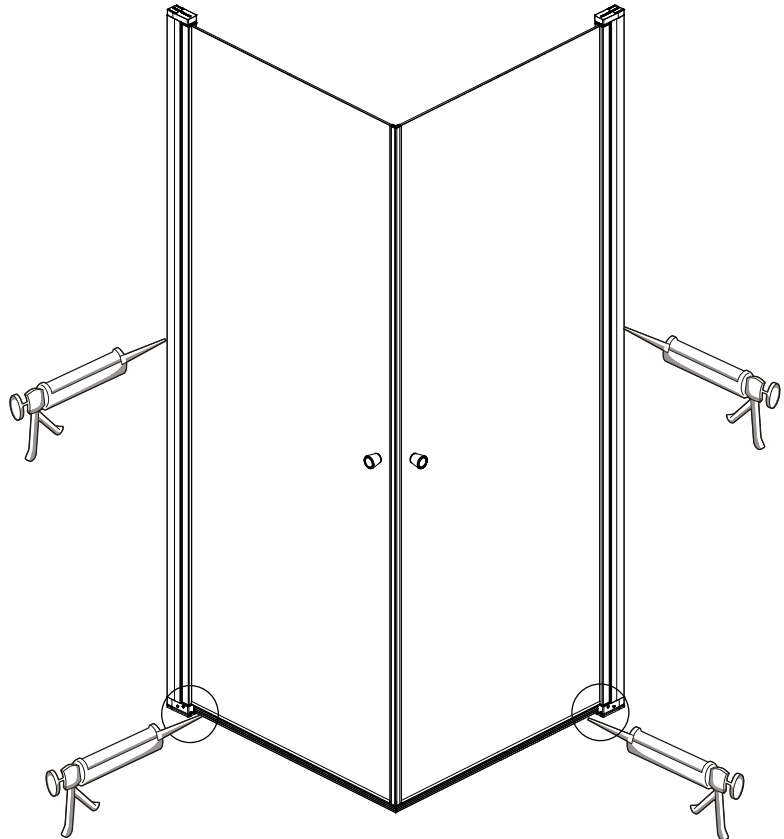
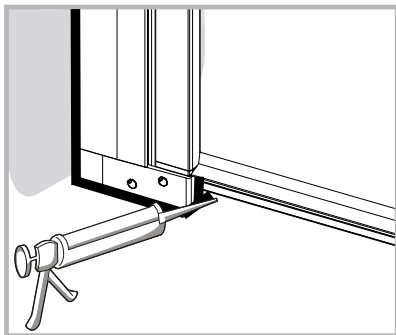
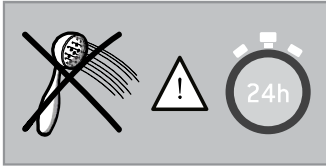

## VEDLIKEHOLD

Under følger generelle vedlikeholdsinstruksjoner for å holde produktet vedlike:

- ✓ Vi anbefaler rengjøring med vaskemidler beregnet for badrom. Bruk en myk klut og unngå bruk av f.eks skuresvamp da dette kan lage riper på produktet. Vann og såperester tørkes av umiddelbart. Unngå: Rengjøringsmiddel med skure-effekt eller innholdende løsmidler! Eksempel: Syrer, klorin, kaustisk soda og amoniakk (salmiak) må ikke brukes!
- ✓ Det er anbefalt å behandle innvendige glassflater med Invisible Shield Gel regelmessig. Dette polerer glasset og vil forenkle rengjøring av dusjen.
- ✓ Det er anbefalt å bruke en dusjnal for å fjerne vann fra overflater etter bruk. Dette vil forenkle det daglige vedlikeholdet.

## GARANTIVILKÅR

VikingBad AS følger norsk kjøpslov med 5 års reklamasjonsrett på fabrikkfeil.

### VED REKLAMASJON / SERVICE

Arbeid dekket av VikingBad AS:

- ✓ Transport tur/retur til kunde.
- ✓ Selve servicearbeidet med reservedeler/ reklamasjonsproduktet.
- ✓ Gjenmontering og silikonerings.

### HVA ER IKKE DEKKET AV KJØPSLOV ELLER GARANTI:

- ✓ Alle følgefeil forårsaket av frostkader som kunde kunne forhindre dekket ikke av reklamasjon
- ✓ Feil som følge av fysisk skade eller ytre påvirkning
- ✓ Feil/skader som følge av feil montering/tilkobling/reparasjoner/endringer av uautorisert personell eller bruk av ikke-originale reservedeler i forbindelse med service/reparasjon.
- ✓ Kostnader som VikingBad AS ikke er direkte skyld i, som f.eks tap av fortjeneste eller annen skade på person/eiendom.
- ✓ Skade/feil på produktet som skyldes feil bruk eller som er i strid med prosedyrer beskrevet i denne brukermanualen.
- ✓ Skraper/riper i overflaten ansees som vanlig slitasje.
- ✓ Skader oppstått grunnet bruk av ikke-anbefalte vaskemidler. Eks syrer og vaskemidler med slipende effekt
- ✓ VikingBad AS fraskriver seg ansvaret for kostnader i forbindelse med reklamasjoner, service eller annet utover selve produktet.

### VIKTIG MED TANKE PÅ REKLAMASJON:

Produktet må være tilgjengelig for serviceperson ved reklamasjon. Det er kjøpers ansvar å sørge for at produktet er tilgjengelig. Dersom fliser, toalett, badromsmøbler eller lignende må demonteres eller eventuelt produkt må løftes opp/ut av innbygning for at serviceperson skal komme til selve produktet påligger dette ansvaret på kjøper. Tid serviceperson bruker for å gjøre produktet tilgjengelig for service/reklamasjon inngår ikke i garanti og faktureres etter timepris.

### GARANTI GJELDER KUN SAMMEN MED GYLDIG KVITTERING OG SERIENUMMER I DET LAND PRODUKTET ER KJØPT.

Denne brukermanualen og innholdet kan endres uten varslings. Selv om VikingBad AS har utarbeidet brukermanualen så nøyaktig som mulig, vil ikke VikingBad AS være økonomisk ansvarlig for tap og skader som følge av feilaktig installasjon, service eller bruk. VikingBad AS tar også forbehold om produktendringer og trykkfeil i brukermanualen.

## Samsvarserklæring VikingBad

Leverandør: VikingBad AS  
Østerskogen 35  
4879 Grimstad  
NORWAY

Produktbeskrivelse: VikingBad Liam Dusjdør rett

Modeller: VB-001373-01, VB-001373-02, VB-001373-03, VB-001373-04, VB-001373-05, VB-001374-01, VB-001374-02, VB-001374-03, VB-001374-04, VB-001374-05

VikingBad AS bekrefter at ovennevnte produkter er testet og funnet i samsvar med følgende teststandard:

EN 12600  
EN 14428:2015+A1:2018



A handwritten signature in black ink, reading 'Kristian Schlanbusch'. The signature is written in a cursive style and is positioned above the printed name and title.

Kristian Schlanbusch  
Produktansvarlig VikingBad as

2018.12.18